

ACDE

EUROPE[®]

+31 (0)316-267291

info@acde-europe.com

www.acde-europe.com

ADVANCED CONSTRUCTION & DEMOLITION EQUIPMENT

 Sloopschaar

 Demolition shear

 Abbruchscherer

 Cisaille de demolition

S803-D HM1000 hole pattern

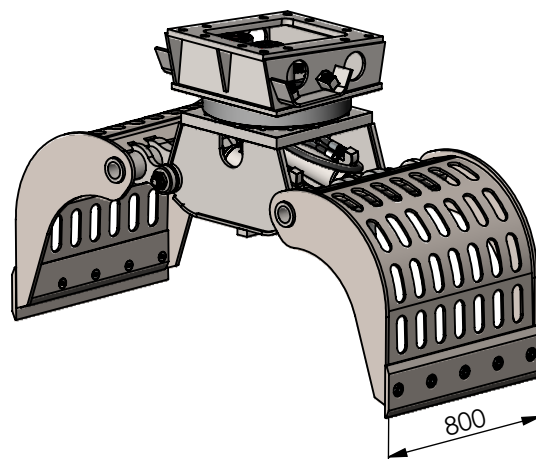

zijkant/side view/
Seitenansicht/vue de côté

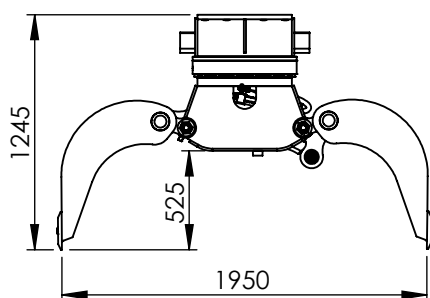



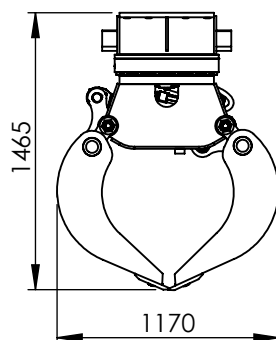

vooraanzicht/front view/
Vorderansicht/vue de face

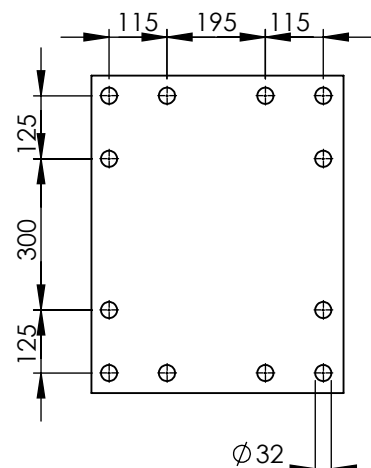

Gatenpatroon/hole pattern/
Bohrbild/motif de trous



Technical specifications

Nederlands 	English 	Deutsch 	Français 		
Klasse graafmachine	Class excavator	Machine klasse	Classe de excavatrice	ton	
Gewicht	Weight	Gewicht	Poids	Kg	12-20
Werkdruk max.	Op. pressure max	Betät. druck max	Pression maximale	bar	935
Werkdruk rotatie max	Op. pressure rotation max	Betät. druck rotation max	Pression rotation max	bar	350
Werkdruk rotatie min	Op. pressure rotation min	Betät. druck rotation min	Pression rotation min	bar	210
Olielof max	Oil flow max	Ölfluss max	Débit d'huile max	l/min	190
Olielof rotatie max	Oil flow rotation max	Ölfluss rotation max	Débit d'huile rotation max	l/min	120
Kracht tussen de messen	Force between the blades	Kraft zwischen den Messern	Force entre les lames	kN	25
Kracht achterin de bek	Force at the back of the jaws	Kraft hinten die Backe	Force arrière les mâchoire	kN	500
Kracht op middelste tand	Force at the middle teeth	Kraft auf dem mittleren Zahn	Force sur la dent médiane	kN	46
Kracht op de punt	Force at the jaw tip	Kraft an der Backenspitze	Force à la pointe de la mâchoire	kN	
Slangaansluiting knijpfunctie	Hose connect open/close	Schlauchanschluss kneifen	Raccord de tuyau fermeture	-	S20
Slangaansluiting draaifunctie	Hose connect turn function	Schlauchanschluss drehen	Raccord de tuyau rotation	-	S16