

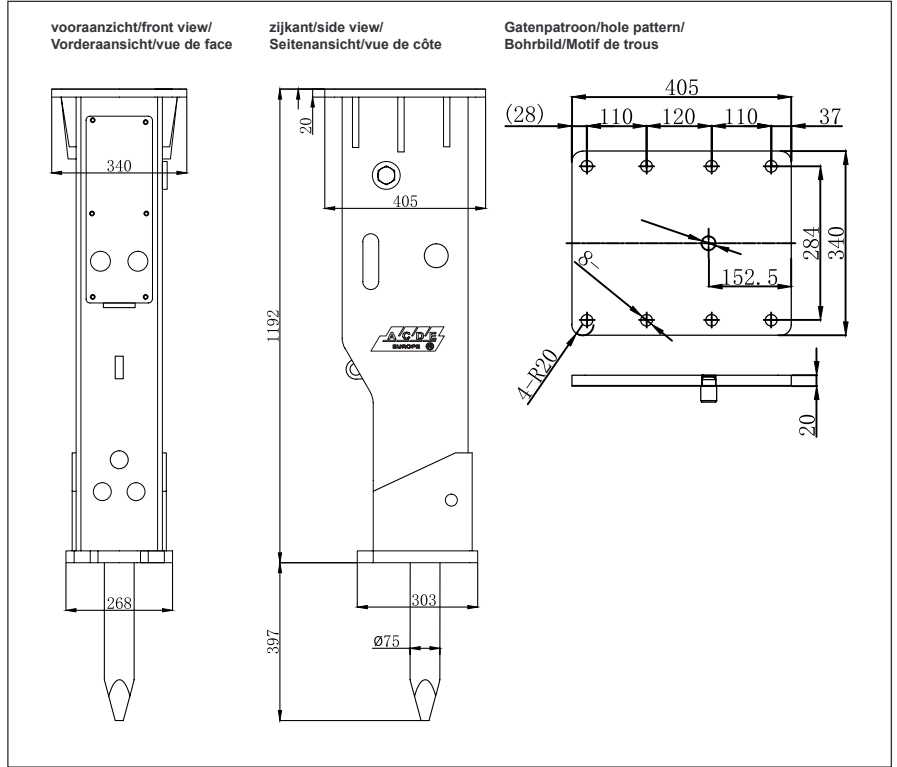



ACDE ASB-75

 **Hydraulische Hamer**  **Hydrauliek Hammer**
 **Hydraulic Breaker**  **Marteaux Hydrauliques**



Technical specifications 01/2018

NEDERLANDS 	DEUTSCH 	ENGLISH 	FRANÇAIS 		ASB-75
WERKGEWICHT	BETRIEBSGEWICHT	WORKING WEIGHT	POIDS EN ORDRE DE MARCHÉ	kg	415
SLAGWERK LENGTE	SCHLAGWERKLÄNGE	CYLINDER LENGHT	LONGUEUR SYSTÈME DE FRAPPE	mm	1110
TOTALE LENGTE	TOTAL LÄNGE	TOTAL LENGTH	LONGUEUR TOTALE	mm	1560
OLIE DEBIET	ÖLMENGE	REQUURED OIL FLOW	DÉBIT D'HUILE	l/min	50 - 90
WERKDRUK	BETRIEBSDRUCK	WORKING PRESSURE	PRESSION DE TRAVAIL	kg/cm ²	120 - 150
SLAGEN PER MINUUT	SCHLAGFREQUENZ	IMPACT RATE	COUPS / MINUTE	bpm	400 - 800
BEITEL DIAMETER	WERKZEUGDURCHMESSER	CHISEL DIA	DIAMÈTRE D'OUTIL	mm	Ø75
BEITEL LENGTE	MEISSEL LÄNGE	CHISEL LENGHT	LONGUEUR D'OUTIL	mm	750
SLANG AANSLUITING	SCHLAUCH ANSCHLUSS	HOSE DIA	CONNECTION TUYAUX	inch	1/2
ZUIGERACCUMULATOR DRUK	KOLBENSPEICHER DRUCK	BACK HEAD PRESSURE	PRESSION PISTON ACCUMULATEUR	kg/cm ²	14 - 17
ACCUMULATOR DRUK	AKKUMULATOR DRUCK	ACCUMULATOR PRESSURE	PRESSION ACCUMULATEUR	kg/cm ²	none
GRAAFMACHINE KLASSE	BAGGERGRÖSSE	APPLICABLE EXCAVATOR	ENGIN PORTEUR CLASSE	ton	6 - 9
SLAGKRACHT	SCHLAGENERGIE	IMPACT POWER	FORCE D'IMPACT	J	785