

ACDE**EUROPE** ®

+31 (0)316-267291

info@acde-europe.com

www.acde-europe.com

Type:

Sloop- en sorteergrijper

Demolition and sorting grab

Abbruch- und Sortiergreifer

Grappin de Demolition et de triage

S1702-ZD

standard hole pattern

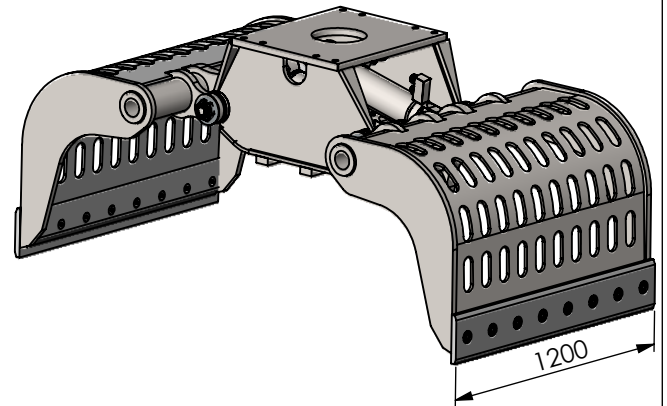
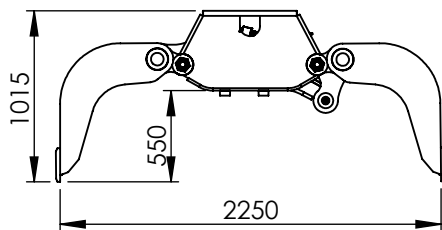
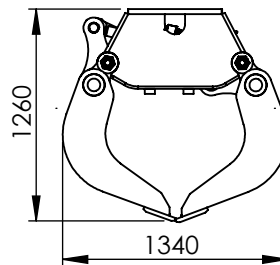
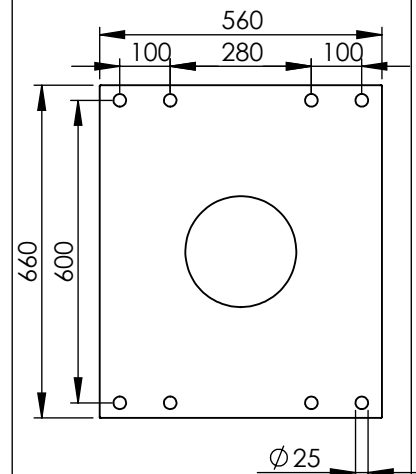
zijkant/side view/
Seitenansicht/vue de côtévooraanzicht/front view/
Vorderansicht/vue de faceGatenpatroon/hole pattern/
Bohrbild/motif de trous

Technical specifications

Nederlands 	English 	Deutsch 	Français 		
Klasse graafmachine	Class excavator	Machine klasse	Classe de excavatrice	ton	23-30
Gewicht	Weight	Gewicht	Poids	Kg	1300
Werkdruk max.	Op. pressure max	Betät. druck max	Pression maximale	bar	350
Olieflow max	Oil flow max	Öfluss max	Débit d'huile max	l/min	150
Inhoud	Content	Inhalt	Contenance	ltr.	750
Sluitkracht	Closing force	Schliesskraft	Force de fermeture	kN	55
Slangaansluiting knijpfunctie	Hose connect open/close	Schlauchanschluss kneifen	Raccord de tuyau fermeture	-	S25
Slangaansluiting draaifunctie	Hose connect turn function	Schlauchanschluss drehen	Raccord de tuyau rotation	-	NA