

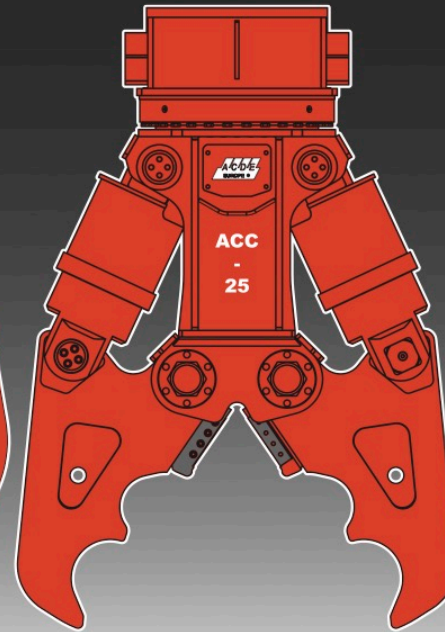

**2025**

**VERKAUFSPROGRAMM | SALES PROGRAM**

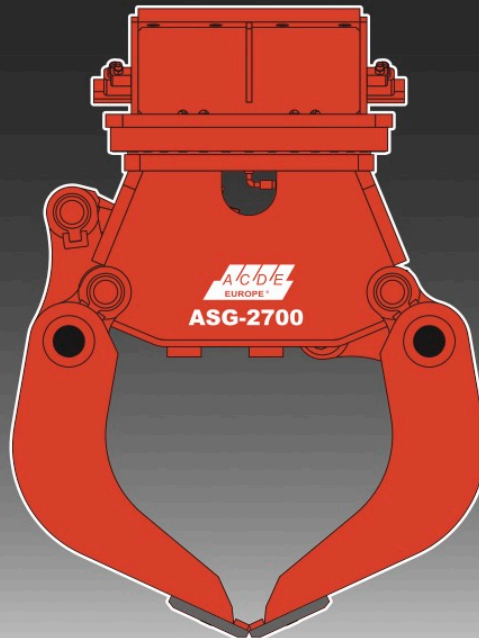
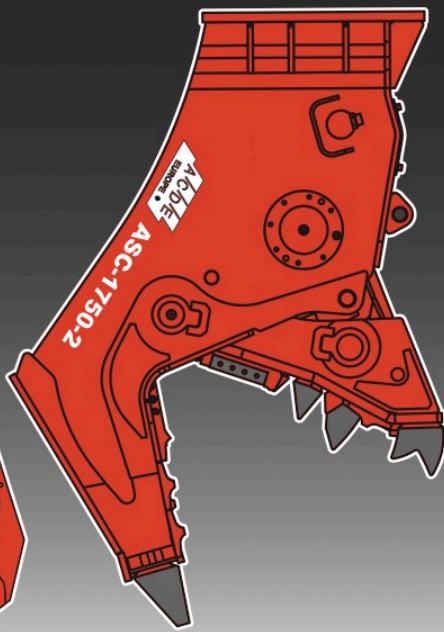

### **ABV-SERIE**

#### **Compactor Plate | Anbauverdichter**

for Excavators from 2 ~ 32 t | für Bagger mit 2 ~ 32 t

### **ACC-SERIE**

#### **Hydraulic Concrete Crusher | Hydraulische Betonzangen**

for Excavators from 10 ~ 36 t | für Bagger mit 10 ~ 36 t

### **AHM-SERIE**

#### **Hydraulic Magnet | Hydraulik - Magnet**

for Excavators from 22 ~ 40 t | für Bagger mit 22 ~ 40 t

### **AMG-ND-SERIE**

#### **Rigid Multi Grapple | Starre Multigreifer**

for Excavators from 1.2 ~ 35 t | für Bagger mit 1.2 ~ 35 t

### **AMG-SERIE**

#### **Multi Grapple | Multigreifer**

for Excavators from 1.2 ~ 35 t | für Bagger mit 1.2 ~ 35 t

### **ARG-SERIE**

#### **Stone Grapple | Steingreifer**

for Excavators from 17 ~ 100 t | für Bagger mit 17 ~ 100 t

### **ASC-SERIE**

#### **Hydraulic Pulverizer | Hydraulische Pulverisierer**

for Excavators from 3 ~ 100 t | für Bagger mit 3 ~ 100 t

### **ASB-SERIE**

#### **Rotating Log Grapple | Drehbare Baumgreifer**

for Excavators from 1.5 ~ 50 t | für Bagger mit 1.5 ~ 50 t

### **ASB-ND-SERIE**

#### **Rigid Log Grapple | Starre Baumgreifer**

for Excavators from 1.5 ~ 50 t | für Bagger mit 1.5 ~ 50 t

### **ASB-7T-SERIE**

#### **Rotating 7 Teeth Log Grapple | Drehbare 7 Zahn Baumgreifer**

for Excavators from 1.5 ~ 38 t | für Bagger mit 1.5 ~ 38 t

### **ASB-7T-ND-SERIE**

#### **Rigid 7 Teeth Log Grapple | Starre 7 Zahn Baumgreifer**

for Excavators from 1.5 ~ 38 t | für Bagger mit 1.5 ~ 38 t

### **ASG-SERIE**

#### **Demolition Grapple | Abbruchgreifer**

for Excavators from 0.7 ~ 50 t | für Bagger mit 0.7 ~ 50 t

### **ASG-ND-SERIE**

#### **Rigid Demolition Grapple | Starre Abbruchgreifer**

for Excavators from 0.7 ~ 50 t | für Bagger mit 0.7 ~ 50 t

### **ASS-SERIE**

#### **Hydraulic Scrap Shear | Schrottscheren**

for Excavators from 6 ~ 35 t | für Bagger mit 6 ~ 35 t

### **AT-SERIE**

#### **Combi Shear | Kombieschere**

for Excavators from 20 ~ 30 t | für mit Bagger 20 ~ 30 t

### **BEILITE® Europe BLTB-5-SERIE**

#### **Hydraulic Hammer | Hydraulikhammer**

for Excavators from 0.5 ~ 200 t | für Bagger 0.5 ~ 200 t

**A C D E**  
EUROPE®

**B-ABV-29-01-2025**

**DA** DEUTSCHER  
ABBRUCHVERBAND

**EDA** EUROPEAN  
DEMOLITION  
ASSOCIATION

**ABV-SERIE Compactor Plate | Anbauverdichter**  
for Excavators from 2 ~ 32 t | für Bagger 2 ~ 32 t



			<b>A</b>	<b>B</b>	<b>C</b>	<b>D</b>	<b>E</b>						
	1*)	2*)	3*)	-	-	-	-	8*)	9*)	11*)	12*)	13*)	14*)
	Kg	t	mm	mm	mm	mm	mm	Kg	N/min	l/min/max	bar	AC	-
<b>ABV-150</b>	150	2-4	650/470					3000	1800	60-70	100-130		
<b>ABV-450</b>	350	5-10	900/550					5000	1800	65-75	110-130		
<b>ABV-650</b>	650	12-18	1160/700					10000	1800	120-140	120-150		
<b>ABV-1100</b>	1100	18-32	1350/900					15000	1800	140-180	120-180		

1\*) WEIGHT, without bracket / GEWICHT ohne Kopfplatte | 2\*) APPLICABLE EXCAVATOR / GEEIGNETER BAGGER | 3\*) PLATE SIZE / GRUNDPLATTE Länge-Breite | 8\*) IMPULS FORCE / IMPULSKRAFT | 9\*) RPM / DREHZAHL | 11\*) WORKING OIL FLOW / ÖLFLUSS | 12\*) SET PRESSURE / EINSTELLDROCK | 13\*) HOLE PATTERN / LOCHBILD | 14\*) BOLT SIZE / SCHRAUBENGRÖSSE



**2025**  
**ACC-SERIE**  
**Hydraulische Betonzange**  
**Hydraulic Concrete Crusher**

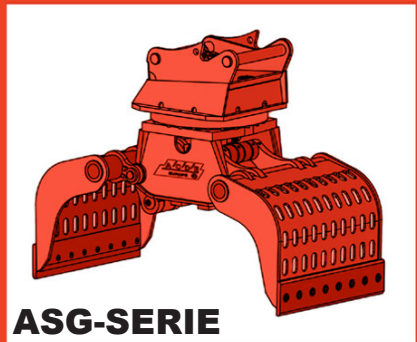

**ASG-SERIE**

**Abbruch-Sortiergreifer**  
**Demolition-Sorting Grapple**

- 80 Modelle - Models  
 - 80 - 2700kg

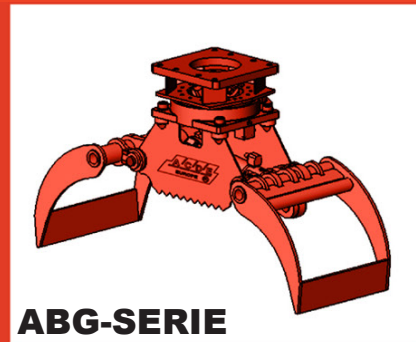

**ABG-SERIE**

**Baumgreifer**  
**Log Grapple**

- 16 Modelle - Models  
 - 50 - 2900kg

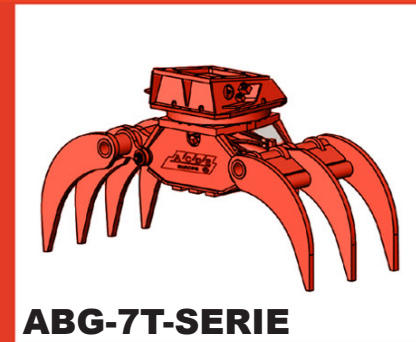

**ABG-7T-SERIE**

**Baumgreifer-7T**  
**Log Grapple-7Tooth**

- 15 Modelle - Models  
 - 160 - 2970kg

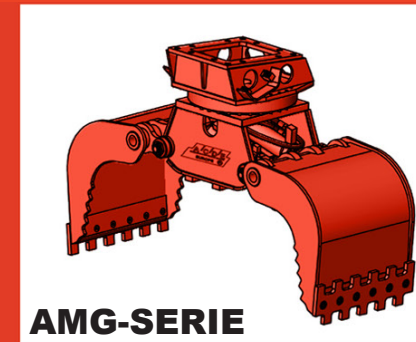

**AMG-SERIE**

**Multigreifer**  
**Multi-Grapple**

- 32 Modelle - Models  
 - 160 - 1800kg



**ARG-SERIE**

**Steingreifer**  
**Stone Grapple**

- 3 Modelle - Models  
 - 2000 - 6880kg

**A C D E**  
EUROPE®

B-ACC-29-01-2025

**DA** **EDA**  
DEUTSCHER  
ABBRUCHVERBAND  
EUROPEAN  
DEMOLITION  
ASSOCIATION

**ACC-SERIE Hydraulic Concrete Crusher | Hydraulische Betonzangen**  
for Excavators from 10 ~ 36 t | für Bagger 10 ~ 36 t

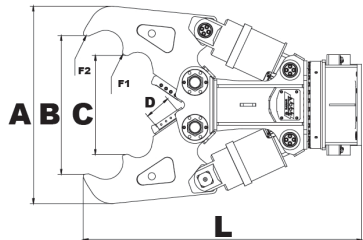
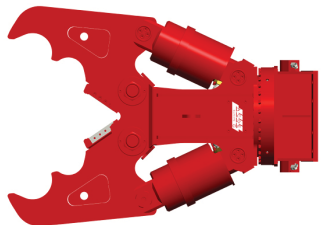

			<b>A</b>	<b>B</b>	<b>C</b>	<b>D</b>	<b>L</b>									
	1*)	2*)	-	-	-	-	-	6*)	7*)	8*)	9*)	10*)	11*)	12*)	14*)	15*)
	Kg	t	mm	mm	mm	mm	mm	kN	kN	°	l/min/max	bar/ min-max	l/min/max	bar	AC	
<b>ACC-10</b>	1100	10-18	1290	900	620	180	1620	790	520	360	30	160	160	350	AC09	M30
<b>ACC-20</b>	1590	12-25	1360	950	680	180	1920	952	625	360	30	160	200	350	AC09	M30
<b>ACC-25</b>	2100	20-35	1495	1050	760	180	1990	1280	785	360	50	160	250	350	AC09	M30
<b>ACC-30</b>	2800	26-36	1850	1200	900	200	2350	1550	900	360	50	160	320	350	AC10	M30
<b>ACC-50</b>	4950	45-70	1290	900	620	180	1620		1380	360	300	120	500	350	AC11	

1\*) WEIGHT, without bracket / GEWICHT ohne Kopfplatte | 6\*) PINCHING FORCE / KNEIFKRAFT | 7\*) PINCHING FORCE / KNEIFKRAFT | 8\*) ROTATION / ROTATION | 9\*) Oil Flow Rotation / Ölfluss Rotation | 10\*) Oil PRESSURE Rotation / ÖDRUCK Rotation | 11\*) WORKING OIL FLOW / ÖLFLUSS | 12\*) SET PRESSURE / EINSTELLDRUCK | 13\*) HOLE PATTERN / LOCHBILD | 14\*) BOLT SIZE / SCHRAUBENGRÖSSE

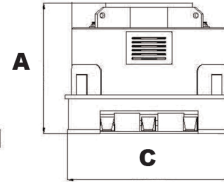
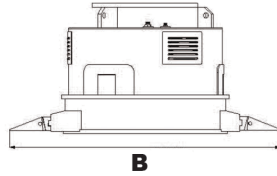
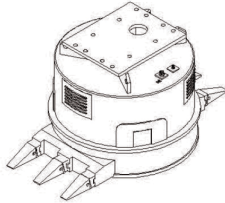

			<b>A</b>	<b>B</b>	<b>C</b>	<b>D</b>						
	1*) Kg	2*) t	- mm	- mm	- mm	- mm	7*) kN	8*) l/min/max	9*) bar	10*) AC	11*) M30	
<b>AHM-100-8Z5</b>	1450	18-32	865	1800	1000	1000	8	60-70	180	AC09	M30	
<b>AHM-125-10Z5</b>	2200	22-40	965	2022	1200	1200	10	60-70	190	AC09	M30	

1\*) WEIGHT, without bracket / GEWICHT ohne Kopfplatte | 2\*) APPLICABLE EXCAVATOR / GEEIGNETER BAGGER | 7\*) POWER/ LEISTUNG | 8\*) WORKING OIL FLOW / ÖLFLUSS | 9\*) SET PRESSURE / EINSTELLD RUCK | 10\*) HOLE PATTERN / LOCHMUSTER | 11\*) BOLT SIZE / SCHRAUBENGRÖSSE



**ACDE**  
**EUROPE®**  
+41 62 58 80 164  
info@acde-europe.com  
www.acde-europe.com

Member of



**DA** : **EDA**  
DEUTSCHER  
ABBRUCHVERBAND    EUROPEAN  
DEMOLITION  
ASSOCIATION



# 2025 AMG-SERIE

## Drehbare Multigreifer Rotating Multi - Grapples

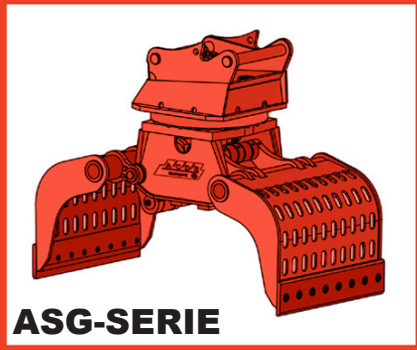

**ASG-SERIE**

**Abbruch-Sortiergreifer  
Demolition-Sorting Grapple**

- 80 Modelle - Models  
- 80 - 2700kg

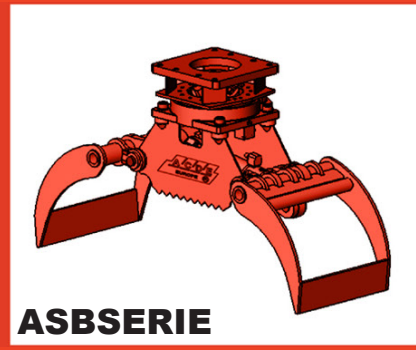

**ASB-SERIE**

**Baumgreifer  
Log Grapple**

- 16 Modelle - Models  
- 50 - 2900kg



**ASB-7T-SERIE**

**Baumgreifer-7T  
Log Grapple-7Tooth**

- 15 Modelle - Models  
- 160 - 2970kg

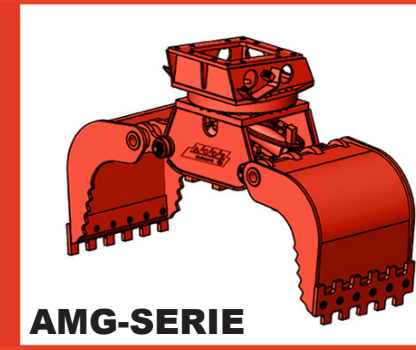

**AMG-SERIE**

**Multigreifer  
Multi-Grapple**

- 32 Modelle - Models  
- 160 - 1800kg

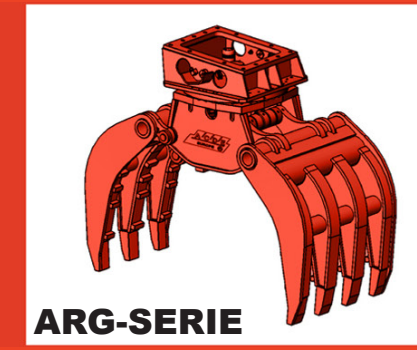

**ARG-SERIE**

**Steingreifer  
Stone Grapple**

- 4 Modelle - Models  
- 2000 - 6880kg

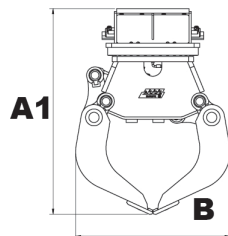
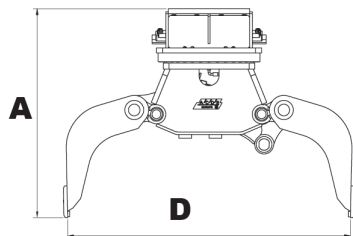
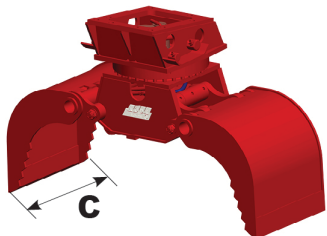

ACDE EUROPE®			<b>A/A1</b>	<b>B</b>	<b>C</b>	<b>D</b>									
	1*)	2*)	mm	mm	mm	mm	7*)	8*)	9*)	10*)	11*)	12*)	13*)	14*)	15*)
	Kg	t					kN	°	l/min/max	bar/ min-max	l/min/max	bar	ltr	AC	
<b>AMG-160-370</b>	58	1.2-3	670	550	370	800	15	360	10	170 - 210	25	300	160	AC03	M16
<b>AMG-280-400</b>	80	3-4	770	780	400	1160	20	360	10	170 - 210	35	300	250	AC03	M16
<b>AMG-280-500</b>	100	3-5	770	780	500	1160	20	360	10	170 - 210	35	300	260	AC03	M16
<b>AMG-460-500</b>	125	4-6	880	850	500	1400	23	360	12	190 - 210	40	300	335	AC05	M16
<b>AMG-500-600</b>	170	5-8	930	885	600	1500	24	360	12	190 - 210	50	300	450	AC05	M16
<b>AMG-600-500</b>	140	6-11	1055	885	500	1550	24	360	15	190-210	70	320	440	AC05	M16
<b>AMG-600-600</b>	170	6-11	1055	885	600	1550	24	360	15	190 - 210	70	320	455	AC05	M16
<b>AMG-600-700</b>	200	6-11	1055	885	700	1550	24	360	15	190 - 210	70	320	465	AC05	M16
<b>AMG-700-600</b>	300	6-11	1100	1050	600	1800	30	360	15	190-210	90	350	580	AC08	M20
<b>AMG-800-600</b>	300	7-12	1160	1070	600	1800	35	360	25	190-210	100	350	760	AC08	M20
<b>AMG-800-700</b>	350	7-12	1160	1070	700	1800	35	360	25	190-210	120	350	800	AC08	M20
<b>AMG-1000-600</b>	380	12-20	1245	1170	600	1950	46	360	25	190-210	120	350	1015	AC09	M30
<b>AMG-1000-700</b>	440	12-20	1245	1170	700	1950	46	360	25	190-210	120	350	1065	AC09	M30
<b>AMG-1500-800</b>	640	17-28	1440	1300	800	2100	68	360	35	190-210	170	350	1380	AC09	M30
<b>AMG-1500-900</b>	720	17-28	1440	1300	900	2100	68	360	35	190-210	170	350	1440	AC09	M30
<b>AMG-2100-1200</b>	950	24-35	1510	1350	1200	2430	80	360	35	190-210	170	350	1800	AC10	M30

1\*) WEIGHT, without bracket / GEWICHT ohne Kopfplatte | 2\*) APPLICABLE EXCAVATOR / GEEIGNETER BAGGER | 7\*) PINCHING FORCE / KNEIFKRAFT | 8\*) ROTATION / ROTATION | 9\*) Oil Flow Rotation / Ölfluss Rotation | 10\*) Oil PRESSURE Rotation / Öldruck Rotation | 11\*) WORKING OIL FLOW / ÖLFLUSS | 12\*) SET PRESSURE / EINSTELLDRUCK | 13\*) VOLUME/ INHALT | 14\*) HOLE PATTERN / LOCHMUSTER | 15\*) BOLT SIZE / SCHRAUBENGRÖSSE





# 2025

# AMG-ND-SERIE

## Starre Multigreifer

## Fixed Multi - Grapples

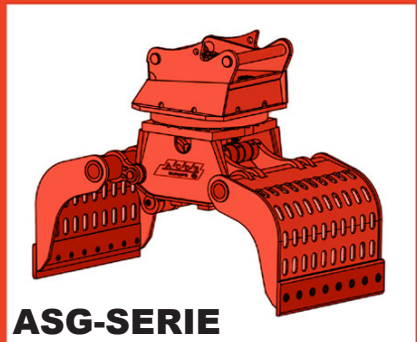

**ASG-SERIE**

**Abbruch-Sortiergreifer**  
**Demolition-Sorting Grapple**

- 80 Modelle - Models  
- 80 - 2700kg

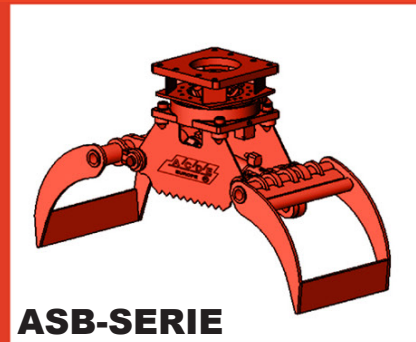

**ASB-SERIE**

**Baumgreifer**  
**Log Grapple**

- 16 Modelle - Models  
- 50 - 2900kg



**ASB-7T-SERIE**

**Baumgreifer-7T**  
**Log Grapple-7Tooth**

- 15 Modelle - Models  
- 160 - 2970kg

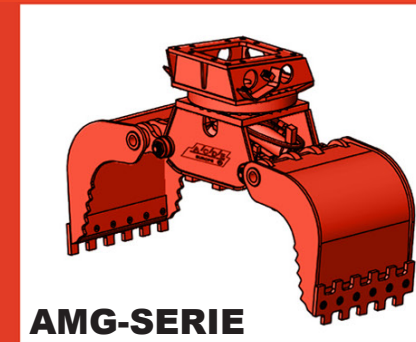

**AMG-SERIE**

**Multigreifer**  
**Multi-Grapple**

- 32 Modelle - Models  
- 160 - 1800kg

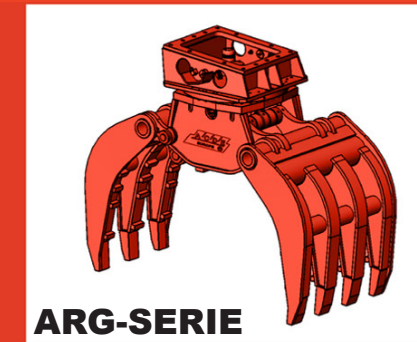

**ARG-SERIE**

**Steingreifer**  
**Stone Grapple**

- 4 Modelle - Models  
- 2000 - 6880kg

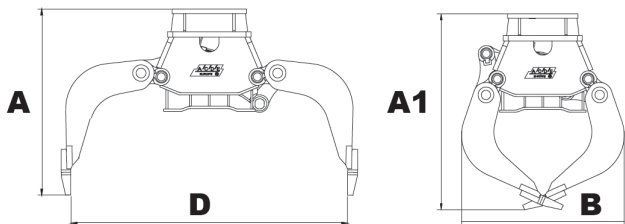
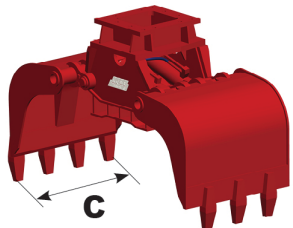

ACDE EUROPE®			<b>A/A1</b>	<b>B</b>	<b>C</b>	<b>D</b>						
	1*)	2*)	-	-	-	-	7*)	11*)	12*)	13*)	14*)	15*)
	Kg	t	mm	mm	mm	mm	kN	l/min/max	bar	ltr	AC	
AMG-160-ND-370	95	1.2-3	700	550	370	800	15	25	300	58	AC03	M16
AMG-280-ND-400	190	2.5-4	850	780	400	1160	20	35	300	80	AC03	M16
AMG-280-ND-500	210	2.5-5	850	780	500	1160	20	35	300	100	AC03	M16
AMG-460-ND-500	280	4-6	950	850	500	1400	23	40	300	125	AC05	M16
AMG-500-ND-600	330	5-8	1000	885	600	1500	24	50	300	170	AC05	M16
AMG-600-ND-500	355	6-11	1100	885	500	1550	24	70	320	140	AC05	M16
AMG-600-ND-600	370	6-11	1100	885	600	1550	24	70	320	170	AC05	M16
AMG-600-ND-700	385	6-11	1100	885	700	1550	24	70	320	200	AC05	M16
AMG-700-ND-600	580	6-11	1100	1050	600	1800	30	90	350	300	AC08	M20
AMG-800-ND-600	560	7-12	1160	1070	600	1800	35	100	350	300	AC08	M20
AMG-800-ND-700	580	7-12	1160	1070	700	1800	35	120	350	350	AC08	M20
AMG-ND-1000-600	770	12-20	1245	1170	600	1950	46	120	350	380	AC09	M30
AMG-ND-1000-700	795	12-20	1300	1170	700	1950	46	120	350	440	AC09	M30
AMG-ND-1500-800	1160	17-28	1500	1300	800	2100	68	170	350	640	AC09	M30
AMG-ND-1500-900	1200	17-28	1500	1300	900	2100	68	170	350	720	AC09	M30
AMG-ND-2100-1200	1450	24-35	1510	1350	1200	2250	80	170	350	950	AC10	M30

1\*) WEIGHT, without bracket / GEWICHT ohne Kopfplatte | 2\*) APPLICABLE EXCAVATOR / GEEIGNETER BAGGER | 7\*) PINCHING FORCE / KNEIFKRAFT | 8\*) ROTATION / ROTATION | 9\*) Oil Flow Rotation / Ölfluss Rotation | 10\*) Oil PRESSURE Rotation / Öldruck Rotation | 11\*) WORKING OIL FLOW / ÖLFLUSS | 12\*) SET PRESSURE / EINSTELLDRUCK | 13\*) VOLUME/ INHALT | 14\*) HOLE PATTERN / LOCHMUSTER | 15\*) BOLT SIZE / SCHRAUBENGRÖSSE



**ACDE**  
**EUROPE®**  
+41 62 58 80 164  
info@acde-europe.com  
www.acde-europe.com

Member of

**2025**  
**ARG-SERIE**  
**Drehbare Steingreifer**  
**Rotating Stone - Grapples**



**DA** : **EDA**  
DEUTSCHER  
ABBRUCHVERBAND    EUROPEAN  
DEMOLITION  
ASSOCIATION



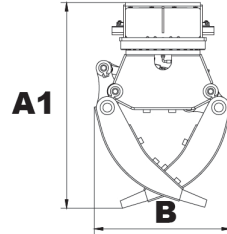
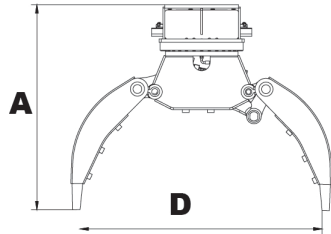

			<b>A/A1</b>	<b>B</b>	<b>D</b>									
	1*)	2*)	-	-	-	7*)	8*)	9*)	10*)	11*)	12*)	13*)	14*)	15*)
	Kg	t	mm	mm	mm	kN	°	l/min/max	bar/ min-max	l/min/max	bar	ltr	AC	M
<b>ARG-1500</b>	1700	17-28	1800	1000	1600	38	360	35	190-210	120	350	600	AC09	M30
<b>ARG-2300</b>	2000	25-38	1495	1200	2410	80	360	35	190-210	180	350	700	AC10	M30
<b>ARG-3100</b>	3030	30-50	1860	1350	2810	90	360	35	190-210	200	350	1250	AC11	M36
<b>ARG-5100</b>	6880	45-100	2540	1470	2800	130	360	35	190-210	250	350	1450	AC014	M36

1\*) WEIGHT, without bracket / GEWICHT ohne Kopfplatte | 2\*) APPLICABLE EXCAVATOR / GEEIGNETER BAGGER | 7\*) PINCHING FORCE / KNEIFKRAFT | 8\*) ROTATION / ROTATION | 9\*) Oil Flow Rotation / Ölfluss Rotation | 10\*) Oil PRESSURE Rotation / Öldruck Rotation | 11\*) WORKING OIL FLOW / ÖLFLUSS | 12\*) SET PRESSURE / EINSTELLD RUCK | 13\*) VOLUME/ INHALT | 14\*) HOLE PATTERN / LOCHMUSTER | 15\*) BOLT SIZE / SCHRAUBENGRÖSSE



# 2025

# ASB-SERIE

## Drehbare Baumgreifer

## Rotating Log - Grapples

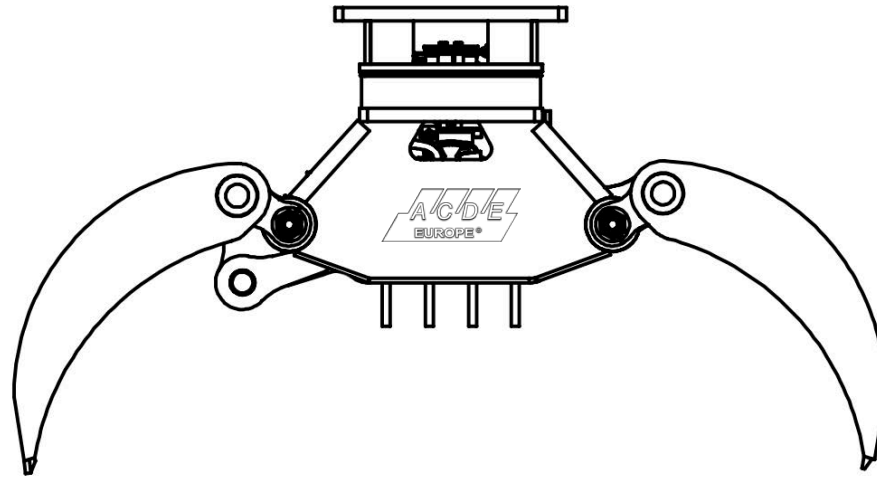

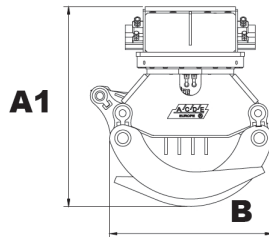
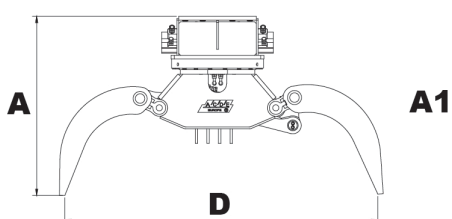
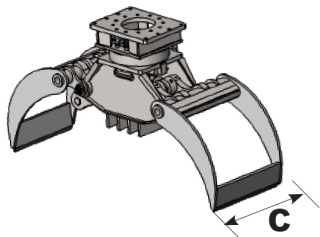

			<b>A/A1</b>	<b>B</b>	<b>C</b>	<b>D</b>									
	1*)	2*)	-	-	-	-	7*)	8*)	9*)	10*)	11*)	12*)	13*)	14*)	15*)
	Kg	t	mm	mm	mm	mm	kN	°	l/min/max	bar/ min-max	l/min/max	bar	ltr	AC	
<b>ASB-160</b>	160	1.5-3	765	450	330	1100	15	360	10	170-210	25	300		AC03	M16
<b>ASB-280</b>	260	3.5-5	780	450	330	1100	15	360	10	170-210	30	300		AC03	M16
<b>ASB-460</b>	400	4-8	850	735	500	1540	15	360	12	190-210	40	300		AC03	M16
<b>ASB-500</b>	440	5-8	863	735	500	1540	24	360	12	190-210	50	300		AC05	M16
<b>ASB-600</b>	550	7-11	1350	735	500	1540	24	360	15	190-210	70	320		AC09	M30
<b>ASB-800</b>	832	10-16	1340	800	535	2050	35	360	25	190-210	100	350		AC09	M30
<b>ASB-1000</b>	1000	13-20	1160	910	652	2050	46	360	35	190-210	120	350		AC09	M30
<b>ASB-1000-2M</b>	1000	13-20	1160	910	652	2050	46	360	35	190-210	120	350		AC09	M30
<b>ASB-1090</b>	1100	16-24	1160	910	652	2050	46	360	35	190-210	120	350		AC09	M30
<b>ASB-1090-2M</b>	1100	16-24	1160	910	652	2050	46	360	35	190-210	120	350		AC09	M30
<b>ASB-1500</b>	1500	17-28	1460	910	810	2250	48	360	35	190-210	160	350		AC09	M30
<b>ASB-1500-2M</b>	1500	17-28	1460	910	810	2250	48	360	35	190-210	160	350		AC09	M30
<b>ASB-1800</b>	1600	20-28	1550	910	810	2250	68	360	35	190-210	160	350		AC09	M30
<b>ASB-1800-2M</b>	1600	20-28	1550	910	810	2250	68	360	35	190-210	160	350		AC09	M30
<b>ASB-2300-2M</b>	1800	25-38	1550	910	810	2250	68	360	35	210-350	160	350		AC10	M30
<b>ASB-2700-2M</b>	2900	30-50	1900	1200	1000	2850	90	360	35	210-350	200	350		AC10	M30

1\*) WEIGHT, without bracket / GEWICHT ohne Kopfplatte | 2\*) APPLICABLE EXCAVATOR / GEEIGNETER BAGGER | 7\*) PINCHING FORCE / KNEIFKRAFT | 8\*) ROTATION / ROTATION | 9\*) Oil Flow Rotation / Ölfluss Rotation | 10\*) Oil PRESSURE Rotation / Öldruck Rotation | 11\*) WORKING OIL FLOW / ÖLFLUSS | 12\*) SET PRESSURE / EINSTELLD RUCK | 13\*) VOLUME/ INHALT | 14\*) HOLE PATTERN / LOCHMUSTER | 15\*) BOLT SIZE / SCHRAUBENGRÖSSE



# 2025

# ASB-ND-SERIE

## Starre Baumgreifer

---

## Rigid Log - Grapples

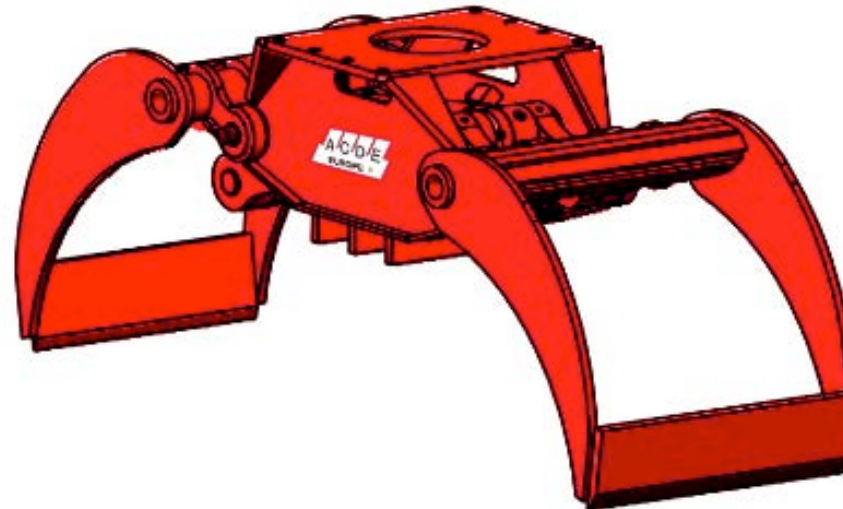
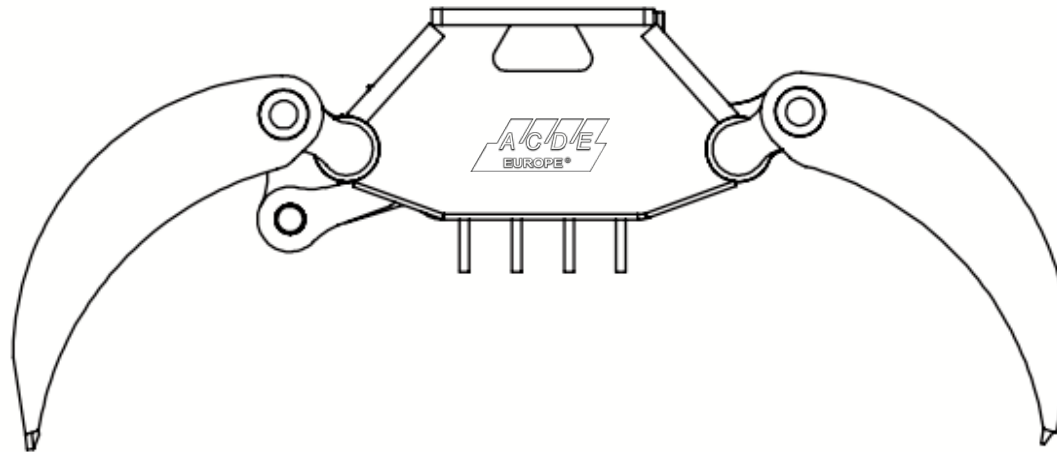

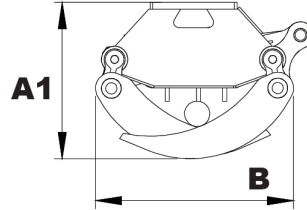
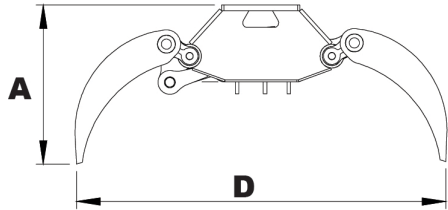

			<b>A/A1</b>	<b>B</b>	<b>C</b>	<b>D</b>						
	1*)	2*)	-	-	-	-	7*)	11*)	12*)	13*)	14*)	15*)
	Kg	t	mm	mm	mm	mm	kN	l/min/max	bar	ltr	AC	
ASB-160-ND	160	1.5-3	765	450	400	1100	15	25	300		AC03	M16
ASB-280-ND	260	3.5-5	780	450	400	1100	15	30	300		AC03	M16
ASB-460-ND	400	4-8	850	550	500	1540	24	40	300		AC03	M16
ASB-500-ND	440	5-8	863	550	500	1540	24	50	300		AC05	M16
ASB-600-ND	500	7-11	1350	550	500	1540	35	100	320		AC09	M30
ASB-800-ND	832	10-16	1340	515	535	2050	35	120	350		AC09	M30
ASB-1000-ND	1000	13-20	1160	735	635	2050	46	120	350		AC09	M30
ASB-1090-ND	1100	16-24	1160	910	652	2050	46	120	350		AC09	M30
ASB-1500-ND	1500	17-28	1460	910	810	2250	48	160	350		AC09	M30
ASB-1800-ND	1600	20-28	1550	910	810	2250	68	160	350		AC09	M30
ASB-2300-ND	1800	25-38	1550	910	810	2250	68	160	350		AC10	M30

1\*) WEIGHT, without bracket / GEWICHT ohne Kopfplatte | 2\*) APPLICABLE EXCAVATOR / GEEIGNETER BAGGER | 7\*) PINCHING FORCE / KNEIFKRAFT | 8\*) ROTATION / ROTATION | 9\*) Oil Flow Rotation / Ölfluss Rotation | 10\*) Oil PRESSURE Rotation / Öldruck Rotation | 11\*) WORKING OIL FLOW / ÖLFLUSS | 12\*) SET PRESSURE / EINSTELLD RUCK | 13\*) VOLUME/ INHALT | 14\*) HOLE PATTERN / LOCHMUSTER | 15\*) BOLT SIZE / SCHRAUBENGRÖSSE



**A/C/D/E**  
**EUROPE®**  
 +41 62 58 80 164  
 info@acde-europe.com  
 www.acde-europe.com

**2025**

**ASB-7T-SERIE**  
**Drehbare 7 Zahn Baumgreifer**  
**Rotating 7 Teeth Log - Grapples**



Member of

**DA** : **EDA**  
 DEUTSCHER ABBRUCHVERBAND    EUROPEAN DEMOLITION ASSOCIATION



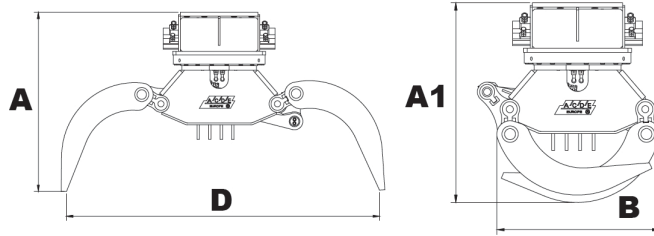
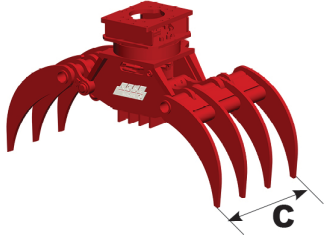

			<b>A/A1</b>	<b>B</b>	<b>C</b>	<b>D</b>									
	1*)	2*)	-	-	-	-	7*)	8*)	9*)	10*)	11*)	12*)	13*)	14*)	15*)
	Kg	t	mm	mm	mm	mm	kN	°	l/min/max	bar/ min-max	l/min/max	bar	ltr	AC	
<b>ASB-160-7T</b>	170	1.5-3	680	450	330	1100	15	360	10	170-210	25	300	40	AC03	M16
<b>ASB-280-7T</b>	210	3.5-5	780	450	330	1100	15	360	10	170-210	30	300	80	AC03	M16
<b>ASB-460-7T</b>	390	4-8	850	735	500	1540	15	360	12	190-210	40	300	80	AC03	M16
<b>ASB-500-7T</b>	460	5-8	870	735	500	1540	24	360	12	210-300	50	300	200	AC05	M16
<b>ASB-600-7T</b>	550	6-11	1100	735	500	1540	24	360	15	210-300	70	350	200	AC08	M16
<b>ASB-800-7T</b>	900	10-16	1170	800	535	2050	35	360	25	210-350	100	350	175	AC09	M30
<b>ASB-800-7T-2M</b>		10-16	1170	800	535	2050	35	360	25			350	175	AC09	M30
<b>ASB-1000-7T</b>	1150	16-24	1160	910	652	2050	46	360	35	210-350	120	350	240	AC09	M30
<b>ASB-1000-7T-2M</b>		16-24	1160	910	652	2050	46	360	35			350	240	AC09	M30
<b>ASB-1500-7T</b>	1700	17-28	1460	1230	840	2250	68	360	35	210-350	160	350	500	AC09	M30
<b>ASB-1500-7T-2M</b>		17-28	1460	1230	840	2250	68	360	35			350	500	AC09	M30
<b>ASB-2300-7T</b>	2100	25-38	1550	1230	840	2250	78	360	35	210-350	170	350	500	AC10	M30

1\*) WEIGHT, without bracket / GEWICHT ohne Kopfplatte | 2\*) APPLICABLE EXCAVATOR / GEEIGNETER BAGGER | 7\*) PINCHING FORCE / KNEIFKRAFT | 8\*) ROTATION / ROTATION | 9\*) Oil Flow Rotation / Ölfluss Rotation | 10\*) Oil PRESSURE Rotation / Öldruck Rotation | 11\*) WORKING OIL FLOW / ÖLFLUSS | 12\*) SET PRESSURE / EINSTELLDRUCK | 13\*) VOLUME/ INHALT | 14\*) HOLE PATTERN / LOCHMUSTER | 15\*) BOLT SIZE / SCHRAUBENGRÖSSE



# 2025

# ASB-7T-ND-SERIE

## Starre 7 Zahn Baumgreifer

---

## Rigid 7 Teeth Log - Grapples

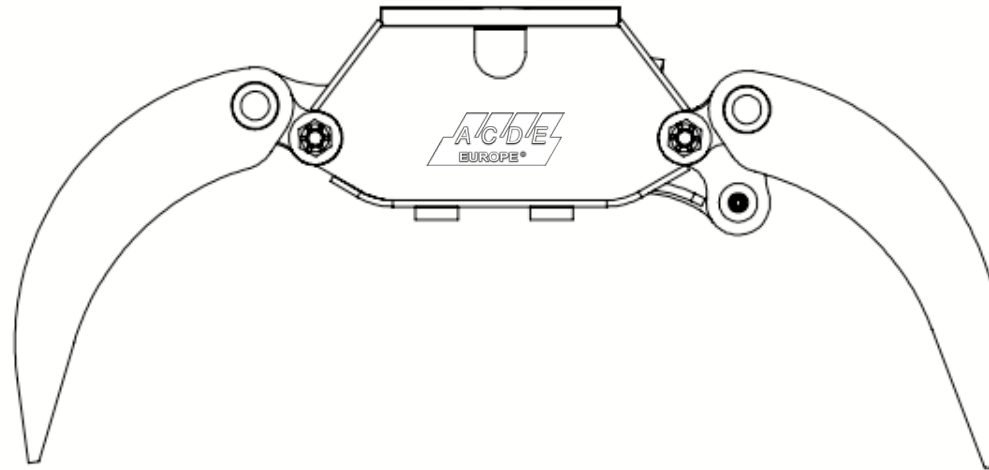

# ASB-7T-ND-SERIE Rigid 7 Teeth Log Grapple | Starre 7 Zahn Baumgreifer

for Excavators from 1.5 ~ 38 t | für Bagger mit 1.5 ~ 38 t

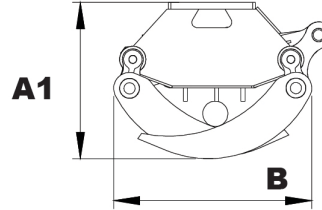
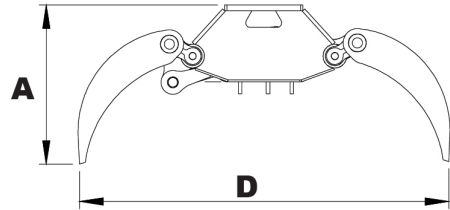
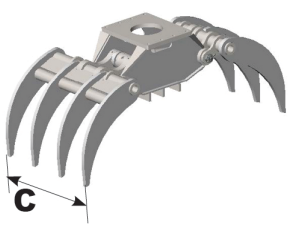

			<b>A/A1</b>	<b>B</b>	<b>C</b>	<b>D</b>						
	1*) Kg	2*) t	- mm	- mm	- mm	- mm	7*) kN	11*) l/min/max	12*) bar	13*) litr	14*) AC	15*)
ASB-160-7T-ND		1.5-3		450	330	1100	15	25	300	40	AC03	M16
ASB-280-7T-ND		3.5-5		450	330	1100	15	30	300	80	AC03	M16
ASB-460-7T-ND		4-8		735	500	1540	15	40	300	80	AC03	M16
ASB-500-7T-ND		5-8		735	500	1540	24	50	300	200	AC05	M16
ASB-600-7T-ND		6-11		735	500	1540	24	70	350	200	AC08	M16
ASB-800-7T-ND		10-16		800	535	2050	35	100	350	175	AC09	M30
ASB-1000-7T-ND		16-24		910	652	2050	46	120	350	240	AC09	M30
ASB-1500-7T-ND		17-28		1230	840	2250	68	160	350	500	AC09	M30
ASB-2300-7T-ND		25-38		1230	840	2250	78	170	350	500	AC10	M30

1\*) WEIGHT, without bracket / GEWICHT ohne Kopfplatte | 2\*) APPLICABLE EXCAVATOR / GEEIGNETER BAGGER | 7\*) PINCHING FORCE / KNEIFKRAFT | 8\*) ROTATION / ROTATION | 9\*) Oil Flow Rotation / Ölfluss Rotation | 10\*) Oil PRESSURE Rotation / Öldruck Rotation | 11\*) WORKING OIL FLOW / ÖLFLUSS | 12\*) SET PRESSURE / EINSTELLD RUCK | 13\*) VOLUME/ INHALT | 14\*) HOLE PATTERN / LOCHMUSTER | 15\*) BOLT SIZE / SCHRAUBENGRÖSSE



# 2025 ASC- SERIE

## Starre Hydraulische Pulverisierer Fixed Hydraulic Pulverizer



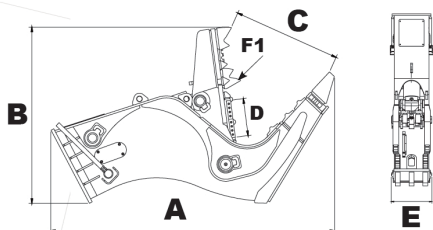
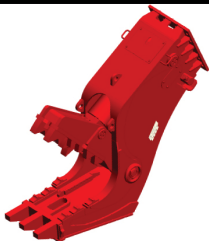

			<b>A</b>	<b>B</b>	<b>C</b>	<b>D</b>	<b>E</b>					
	1*)	2*)	-	-	-	6*)	-	8*)	9*)	10*)	11*)	12*)
	Kg	t	mm	mm	mm	mm		kN	l/min/max	bar	AC	
ASC-260	260	3-6	1075	700	400	80	250	285	30-50	240	AC03	M16
ASC-360	360	6-9	1260	780	520	120	290	315	40-60	240	AC05	M16
ASC-1350	1050	10-18	1898	1162	700	180	460	585	80-160	350	AC09	M30
ASC-1750-2	1750	18-24	2065	1314	890	180	584	877	160-240	350	AC09	M30
ASC-1750-2M	2100	18-24	2065	1680	880	180	584	877	160-240	350	AC09	M30
ASC-2750-2	2750	30-40	2750	1702	1050	360	674	1125	220-350	350	AC10	M30
ASC-4750	4800	40-100	3110	2100	1450	360	720	1500	310-480	350	AC14	M36

1\*) WEIGHT, without bracket / GEWICHT ohne Kopfplatte | 2\*) APPLICABLE EXCAVATOR / GEEIGNETER BAGGER | 6\*) KNIFE LENGTH / MESSERLÄNGE | 8\*) PINCHING FORCE / KNEIFKRAFT | 9\*) WORKING OIL FLOW / ÖLFLUSS | 10\*) SET PRESSURE / EINSTELLDRUCK | 11\*) HOLE PATTERN / LOCHMUSTER | 12\*) BOLT SIZE / SCHRAUBENGRÖSSE



# 2025 ASG-SERIE

## Abbruch und Sortiergreifer

### Demolition and Sorting Grapples





# ACDE® Europe ASG-SERIE

## Abbruch & Sortiergreifer / Demolition and Sorting Grapple

für Bagger von 0.7-50 t  
für Excavators from 0.7-50 t



### Standardmäßig 360° drehbar

Alle unser Greifer sind ausgezeichnete zu handhaben und Dank des 360° Drehwerks vielseitig einsetzbar

### 360° rotatable as standard

All our grapples are excellent to handle and versatile thanks to the 360° slew gear

### Leistungsfähige Hydraulikzylinder

Absolute Kontrolle durch nahezu konstanter Schließkraft

### Powerful hydraulic cylinders

Absolute control through almost constant closing force

### Zuverlässige Handhabung

Fester Griff für zuverlässige Handhabung des gegriffenen Materials

### Reliable handling

Firm grip for reliable handling of the gripped materials

### Höhere Effizienz

Ein grösseres Schalenvolumen für wirtschaftlicheres Sortieren und Verladen

### Greater efficiency

A larger bucket volume for more economical sorting and loading



### Wärmebehandelte Kolbenstangen

Verchromte, unverwüßliche Kolbenstangen für besseren Schutz vor Beschädigungen

### Heat treated piston rods

Chrome-plated, indestructible piston rods for better protection against damage

### Synchronisierte Schalen

Präzise Handhabung zum greifen dünner Materialien

### Synchronized shells

Precise handling for gripping thin materials

### Verschleißfester Stahl

Greifschalen und Gehäuse sind äußerst robust gefertigt und halten auch härtesten Einsatzbedingungen stand

### Wear-resistant steel

Shells and housing are extremely robust and withstand even the toughest operating conditions

### Austausch - und wendbare Messer

Sehr niedrigere Gesamtkosten und Investition Dank wirtschaftlichem Design

### Exchange - and reversible knives

Very lower total cost and Investment thanks to economical design





ACDE®Europe ASG-SERIE				ACDE®Europe S-SERIE			
Modell/ Model	Bagger/ Excavator	Gewicht/ Weight kg	Breite/ Width mm	Modell/ Model	Bagger/ Excavator	Gewicht/ Weight kg	Breite/ Width mm
ASG-80	0.8 - 1.2	80	300	S75D	0.7 - 1.2	75	300
ASG-105	1-2	105	350	S100D	1 - 2	90	350
ASG-160	1.2-3	160	450	S150D	1.2 - 3	140	450
ASG-280	3-5	280	500	S300D	3 - 5	280	500
ASG-460	4-6	400	600	S400D	4 - 6	350	600
ASG-500	5-8	435	700	S450D	5 - 8	400	700
ASG-600	7-11	500	700	S452D	7 - 11	450	700
ASG-700	9-12	600	600	S502D	9 - 12	600	600
ASG-800	10-16	832	800	S602D	10 - 16	840	800
ASG-1000	12-20	1070	800	S803D	12 - 20	1000	800
ASG-1090	13-20	1110	900	S903D	13 - 20	1050	900
ASG-1100	16-20	1145	1000	S1003D	16 - 20	1070	1000
ASG-1200	16-25	1360	900	S1102D	16 - 25	1400	900
ASG-1500	17-28	1420	1000	S1202D	17 - 28	1440	1000
ASG-1800	20-28	1480	1200	S1402D	20 - 28	1600	1200
ASG-2100	23-30	1750	1200	S1702D	23 - 30	1750	1200
ASG-2300	25-38	1880	1200	S1902D	25 - 38	1900	1200
ASG-2700	28-40	2500	1200	S2500D	28 - 40	2500	1200
ASG-2900	30-50	2700	1360	S2700D	30 - 50	2700	1360
ASG-3100	35-50	2900	1500	S3000D	35 - 50	3000	1500

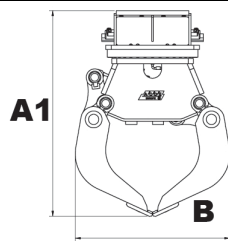
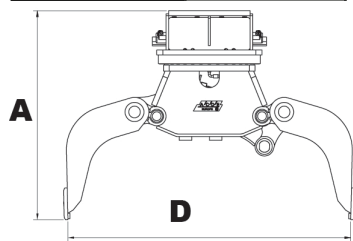
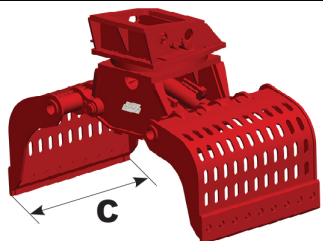

ACDE EUROPE®			<b>A/A1</b>	<b>B</b>	<b>C</b>	<b>D</b>									
	1*) Kg	2*) t	mm	mm	mm	mm	7*) kN	8*) °	9*) l/min/max	10*) bar/ min-max	11*) l/min/max	12*) bar	13*) ltr	14*) AC	15*)
<b>ASG-80</b>	80	0.8 - 1.2	595 / 600	430	300	600	6	360	5	170 - 210	15	300	30	AC02	M16
<b>ASG-105</b>	105	1-2	610 / 670	500	350	770	7	360	5	170 - 210	20	300	40	AC02	M16
<b>ASG-160</b>	160	1.2-3	650 / 670	545	450	800	15	360	10	170 - 210	25	300	70	AC03	M16
<b>ASG-280</b>	280	3-5	770 / 850	780	500	1160	20	360	10	170 - 210	35	300	100	AC03	M16
<b>ASG-460</b>	400	4-6	880 / 1010	850	600	1400	23	360	12	190 - 210	40	300	150	AC05	M16
<b>ASG-500</b>	435	5-8	910/1085	905	700	1520	24	360	12	190-210	50	300	200	AC05	M16
<b>ASG-600</b>	500	7-11	990 / 1156	885	700	1550	24	360	15	190 - 210	70	320	200	AC08	M20
<b>ASG-700</b>	600	9-12	1050 / 1220	1055	600	1700	30	360	15	190 - 210	90	350	300	AC08	M20
<b>ASG-800</b>	832	10-16	1140 / 1315	1070	800	1750	35	360	25	190-210	100	350	400	AC09	M30
<b>ASG-1000</b>	1070	12-20	1245 / 1456	1175	800	1950	46	360	25	190-210	120	350	500	AC09	M30
<b>ASG-1090</b>	1110	13-20	1245 / 1456	1175	900	1950	46	360	25	190-210	120	350	600	AC09	M30
<b>ASG-1100</b>	1145	16-20	1245 / 1456	1175	1000	1950	46	360	25	190-210	120	350	700	AC09	M30
<b>ASG-1200</b>	1360	16-25	1485/1675	1300	900	2100	55	360	35	190-210	160	350	750	AC09	M30
<b>ASG-1500</b>	1420	17-28	1485/1675	1340	1000	2100	55	360	25	190-210	160	350	800	AC09	M30
<b>ASG-1800</b>	1480	20-28	1485/1675	1300	1200	2100	55	360	35	190-210	160	350	850	AC09	M30
<b>ASG-2100</b>	1750	23-30	1430/1695	1340	1200	2250	68	360	35	190-210	170	350	900	AC09	M30
<b>ASG-2300</b>	1880	25-38	1460/1690	1350	1200	2250	80	360	35	190-210	170	350	950	AC10	M30
<b>ASG-2700</b>	2500	28-40	1635/1830	1370	1200	2250	90	360	35	190-210	200	350	1000	AC10	M30
<b>ASG-2900</b>	2700	30-50	1635/1830	1370	1360	2250	90	360	35	190-210	200	350	1100	AC10	M30
<b>ASG-3100</b>	2900	30-50	1654/1945	1385	1500	2450	90	360	35	190-210	200	350	1210	AC10	M30
<b>ASG-4100</b>	3910	40-65	1800/2050	1755	1500	2850	110	360	40	190-210	250	350	1500	AC14	M36
<b>ASG-4900</b>	4100	45-80	1800/2090	1755	1500	2850	110	360	50	190-210	250	350	1500	AC14	M36
<b>ASG-5100</b>	5000	45-100	1880/2200	1890	1500	3000	130	360	60	190-210	250	350	1600	AC14	M36

1\*) WEIGHT, without bracket / GEWICHT ohne Kopfplatte | 2\*) APPLICABLE EXCAVATOR / GEEIGNETER BAGGER | 7\*) PINCHING FORCE / KNEIFKRAFT | 8\*) ROTATION / ROTATION | 9\*) Oil Flow Rotation / Ölfluss Rotation | 10\*) Oil PRESSURE Rotation / Öldruck Rotation | 11\*) WORKING OIL FLOW / ÖLFLUSS | 12\*) SET PRESSURE / EINSTELLD RUCK | 13\*) VOLUME/ INHALT | 14\*) HOLE PATTERN / LOCHBILD | 15\*) BOLT SIZE / SCHRAUBENGRÖSSE

**A/C/D/E**  
**EUROPE®**  
 +41 62 58 80 164  
 info@acde-europe.com  
 www.acde-europe.com

**2025**

# **ASG-ND-SERIE**

**Starre Abbruch und Sortiergreifer**  
**Fixed Demolition and Sorting Grapples**



**DA** : **EDA**  
 DEUTSCHER ABBRUCHVERBAND | EUROPEAN DEMOLITION ASSOCIATION



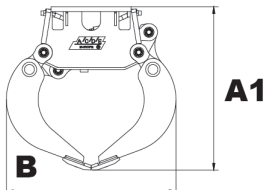
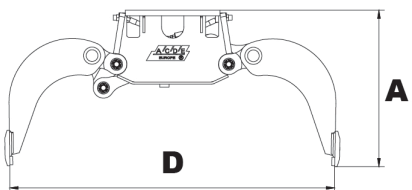
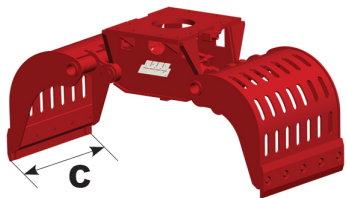

ACDE EUROPE®			<b>A/A1</b>	<b>B</b>	<b>C</b>	<b>D</b>	<b>F</b> kN 1					
	1*) Kg	2*) t	mm	mm	mm	mm	7*) kN	11*) l/min/max	12*) bar	13*) litr	14*) AC	15*)
ASG-80-ND	50	0.7 - 1.2	420	XXX	300	600	6	15	300	30	AC02	M16
ASG-105-ND	65	1-2	450	XXX	350	770	7	20	300	40	AC02	M16
ASG-160-ND	100	1.2-3	550	XXX	450	800	15	25	300	70	AC03	M16
ASG-280-ND	200	2.5-5	650	XXX	500	1160	20	25	300	100	AC03	M16
ASG-460-ND	280	4-6	800	XXX	600	1400	23	40	300	150	AC05	M16
ASG-500-ND	330	5-9	820	XXX	700	1520	24	50	300	200	AC05	M16
ASG-600-ND	340	6-10	710	XXX	700	1550	24	70	300	200	AC08	M20
ASG-700-ND	500	7-12	1050	XXX	600	1700	30	90	350	300	AC08	M20
ASG-800-ND	600	10-16	950	XXX	800	1750	35	100	350	400	AC09	M30
ASG-1000-ND	775	12-20	1100	XXX	800	1950	46	120	350	500	AC09	M30
ASG-1090-ND	785	13 - 20	1100	XXX	900	1950	46	120	350	600	AC09	M30
ASG-1100-ND	800	16 - 20	1100	XXX	1000	1950	46	120	350	700	AC09	M30
ASG-1200-ND	1100	16 - 25	1200	XXX	900	2100	55	160	350	750	AC09	M30
ASG-1500-ND	1200	17 - 28	1200	XXX	100	2100	55	160	350	800	AC09	M30
ASG-1800-ND	1300	20 - 28	1200	XXX	1200	2100	55	160	350	850	AC09	M30
ASG-2100-ND	1330	23 - 30	1200	XXX	1200	2250	80	170	350	900	AC09	M30
ASG-2300-ND	1500	25 - 38	1250	XXX	1200	2250	80	180	350	900	AC10	M30
ASG-2700-ND	1900	28 - 40	1270	XXX	1200	2250	90	200	350	1000	AC10	M30
ASG-2900-ND	2100	30 - 50	1300	XXX	1360	2250	90	200	350	1100	AC10	M30

1\*) WEIGHT, without bracket / GEWICHT ohne Kopfplatte | 2\*) APPLICABLE EXCAVATOR / GEEIGNETER BAGGER | 7\*) PINCHING FORCE / KNEIFKRAFT | 8\*) ROTATION / ROTATION | 9\*) Oil Flow Rotation / Ölfluss Rotation | 10\*) Oil PRESSURE Rotation / Öldruck Rotation | 11\*) WORKING OIL FLOW / ÖLFLUSS | 12\*) SET PRESSURE / EINSTELLD RUCK | 13\*) VOLUME/ INHALT | 14\*) HOLE PATTERN / LOCHBILD | 15\*) BOLT SIZE / SCHRAUBENGRÖSSE

**A/C/D/E**  
**EUROPE®**

+41 62 58 80 164

info@acde-europe.com

www.acde-europe.com

Member of

# 2025

# ASS-SERIE

## Schrottschere

## Hydraulic Scrap Shear

A/C/D/E  
EUROPE



**DA** : **EDA**  
DEUTSCHER  
ABBRUCHVERBAND      EUROPEAN  
DEMOLITION  
ASSOCIATION



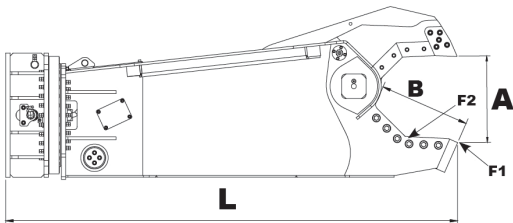

			<b>A</b>	<b>B</b>	<b>L</b>	<b>F</b> kN 1	<b>F</b> kN 2							
	1*)	2*)	-	-	-	6*)	7*)	8*)	9*)	10*)	11*)	12*)	13*)	14*)
	Kg	t	mm	mm	mm	kN	kN	°	l/min/max	bar/ min-max	l/min/max	bar	AC	
<b>ASS-06</b>	580	6-9	350	358	1990	510	920	360	20	100	120	245	AC08	M20
<b>ASS-12</b>	1180	12-25	420	480	2250	620	1430	360	30	120	140	350	AC09	M30
<b>ASS-20</b>	2150	20-35	510	540	2710	850	1480	360	30	120	250	350	AC09	M30
<b>ASS-30</b>	3100	25-35	600	630	3580	1175	2250	360	35	120	250	350	AC010	M30

1\*) WEIGHT, without bracket / GEWICHT ohne Kopfplatte | 2\*) APPLICABLE EXCAVATOR / GEEIGNETER BAGGER | 6\*) PINCHING FORCE / KNEIFKRAFT | 7\*) PINCHING FORCE / KNEIFKRAFT | 8\*) ROTATION / ROTATION | 9\*) Oil Flow Rotation / Ölfluss Rotation | 10\*) Oil PRESSURE Rotation / Öldruck Rotation | 11\*) WORKING OIL FLOW / ÖLFLUSS | 12\*) SET PRESSURE / EINSTELLDRUCK | 13\*) HOLE PATTERN / LOCHBILD | 14\*) BOLT SIZE / SCHRAUBENGRÖSSE

**A/C/D/E**  
**EUROPE®**  
+41 62 58 80 164  
info@acde-europe.com  
www.acde-europe.com

# 2025 AT-SERIE Kombischiere Combi Shear

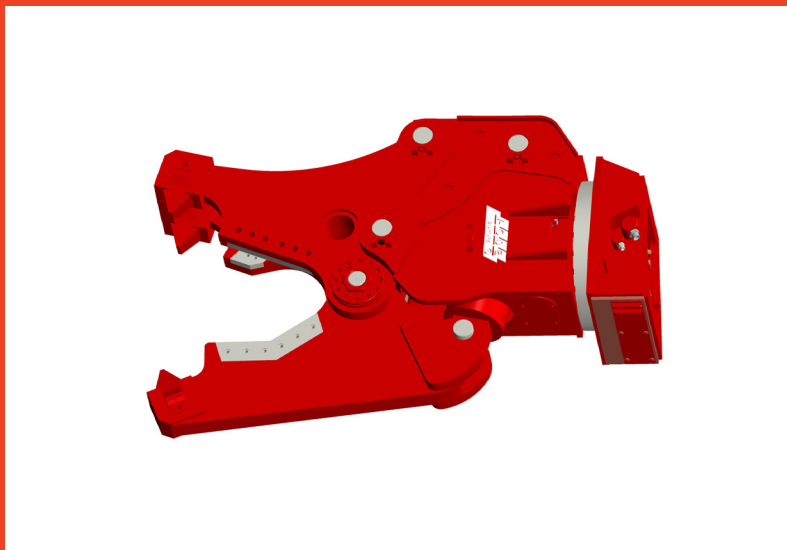

**DA** : **EDA**  
DEUTSCHER  
ABBRUCHVERBAND    EUROPEAN  
DEMOLITION  
ASSOCIATION



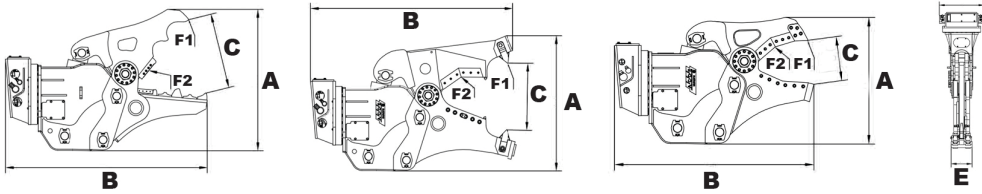

ACDE EUROPE®			<b>A</b>	<b>B</b>	<b>C</b>	<b>D</b>	<b>E</b>									
	1*)	2*)	-	-	-	-	-	8*)	9*)	10*)	11*)	12*)	13*)	14*)	15*)	16*)
	Kg	t	mm	mm	mm	mm	mm	kN	kN	°	l/min/max	bar/ min-max	l/min/max	bar	AC	-
<b>ATB-25</b>	2050	20-30	1550	2220	820	765	150	655	2650	360	30	160	250	350		
<b>ATC-25</b>	2490	20-30	1510	2265	745	765	360	810	1135	360	30	160	250	350		
<b>ATS-25</b>	2100	20-30	1280	2050	450	765	315	960	1560	360	30	160	250	350		

1\*) WEIGHT, without bracket / GEWICHT ohne Kopfplatte | 2\*) APPLICABLE EXCAVATOR / GEEIGNETER BAGGER | 8\*) PINCHING FORCE / KNEIFKRAFT | 9\*) PINCHING FORCE / KNEIFKRAFT | 10\*) ROTATION / ROTATION | 11\*) Oil Flow Rotation / Ölfluss Rotation | 12\*) Oil PRESSURE Rotation / Öldruck Rotation | 13\*) WORKING OIL FLOW / ÖLFLUSS | 14\*) SET PRESSURE / EINSTELLDRUCK | 15\*) HOLE PATTERN / LOCHBILD | 16\*) BOLT SIZE / SCHRAUBENGRÖSSE





2025

# BLTB-5 SERIE

## Hydraulische Hammer

## Hydraulic Breaker

Member of



**Leichte Hammer**  
**Light Breakers**

- für 0,8 - 11 t Bagger  
- for 0,8 - 11 t Excavators



**Mittlere Hammer**  
**Medium Breakers**

- für 10 - 36 t Bagger  
- for 10 - 36 t Excavators



**Schwere Hammer**  
**Heavy Breakers**

- für 38 - 160 t Bagger  
- for 38 - 160 t Excavators



**Kopfplatten**  
**Brackets**

- 30 Modelle/ Models  
- MS/ CW/ SW/



**Mitgeliefertes Zubehör**  
**Supplied equipment**

	1*)	2*)	3*)	4*)	5*)	6*)	7*)	8*)	9*)	10*)	11*)	12*)	13*)	14*)	15*)		20*)
	kg	mm	t	l/min	bar	bar	bpm	mm	mm	inch	bar	bar	m	AC			
<b>BLTB-40-5</b>	96	973	0.5~1.2	15~30	130	90~120	800~1400	40	450	1/2	14~17	/	2~5	AC02	M16	16*)	optional
<b>BLTB-45-5</b>	133	980	0.8~1.5	20~40	140	90~120	700~1200	45	500	1/2	14~17	/	3~6	AC02	M16	16*)	optional
<b>BLTB-53-5</b>	172	1036	1.5~3.5	20~50	150	90~120	600~1100	53	580	1/2	14~17	/	4~8	AC03	M16	16*)	optional
<b>BLTB-60-5</b>	295	1223	3~5.5	30~60	160	100~130	500~1000	60	600	1/2	14~17	/	4~8	AC05	M16	16*)	optional
<b>BLTB-70-5</b>	345	1400	4.5~6	40~70	160	110~140	500~900	70	700	1/2	14~17	55~60	5~10	AC05	M16	16*)	optional
<b>BLTB-75-5</b>	442	1550	6~8.5	50~90	180	120~150	400~800	75	750	1/2	14~17	55~60	6~12	AC06	M20	16*)	optional
<b>BLTB-85-5</b>	624	1803	7~11	60~100	180	130~160	400~800	85	850	3/4	14~17	55~60	6~12	AC08	M20	16*)	optional
<b>BLTB-100A-5-W</b>	1020	2081	10~14	80~110	210	150~170	350~700	100	1000	3/4	14~17	55~60	7~14	AC09	M30	17*)	optional
<b>BLTB-125A-5-W</b>	1245	2287	14~18	90~120	210	150~170	350~650	125	1100	1	14~17	55~60	10~18	AC09	M30	17*)	optional
<b>BLTB-135A-5-W</b>	1521	2381	18~22	120~180	210	160~180	350~500	135	1200	1	14~17	55~60	16~22	AC09	M30	17*)	optional
<b>BLTB-140A-5-W</b>	1750	2417	20~24	120~180	210	160~180	350~500	140	1250	1	14~17	55~60	16~22	AC09	M30	17*)	optional
<b>BLTB-150-5-W</b>	2182	2657	24~27	150~210	230	180~200	200~300	150	1400	1	17~20	55~60	21~30	AC09	M30	17*)	optional
<b>BLTB-155-5-W</b>	2482	2762	27~33	180~240	250	200~220	200~300	155	1400	1	17~20	55~60	21~30	AC010	M30	17*)	optional
<b>BLTB-165-5-W</b>	2985	2800	33~38	200~260	260	210~230	150~300	165	1400	1	18~22	55~60	26~35	AC011	M30	17*)	optional
<b>BLTB-175L-5-W</b>	4107	3238	40~50	220~270	280	230~250	130~200	175	1450	1 1/4	25~28	55~60	35~40	AC011	M36	18*)	standard
<b>BLTB-190-5-W</b>	4990	3334	45~55	240~290	300	250~270	100~140	190	1500	1 1/4	27~30	65~70	38~45	AC013	M36	18*)	standard
<b>BLTB-195-5-W</b>	5120	3454	50~60	260~310	310	260~280	100~140	195	1600	1 1/4	30~33	65~70	45~50	AC013	M36	18*)	standard
<b>BLTB-200-5-W</b>	5240	3555	50~65	280~330	330	280~300	100~130	200	1620	1 1/4	27~30	65~70	48~52	AC013	M36	18*)	standard
<b>BLTB-205-5-W</b>	6532	3778	55~65	320~380	330	280~300	100~130	205	1750		32~35	75~80	50~55	AC014	M36	18*)	standard
<b>BLTB-210L-5-W</b>	7253	3850	60~75	340~400	330	280~300	100~130	210	1800	1 1/4	32~35	75~80	50~55	AC014	M36	18*)	standard
<b>BLTB-215-5-W</b>	7668	3947	65~75	360~420	350	280~300	90~120	215	1800	1 1/2	32~35	75~80	50~55	AC014	M36	18*)	standard
<b>BLTB-220-5-W</b>	9365	4134	68~85	390~450	350	300~330	80~110	220	1900		32~35	75~80	55~60	AC015	M36	18*)	standard
<b>BLTB-230-5-W</b>	10033	4312	75~100	400~460	350	300~330	80~110	230	2000	1 1/2	30~33	75~80	60~65	AC015	M36	18*)	standard
<b>BLTB-235-5-W</b>	10207	4352	75~100	420~480	350	300~330	80~110	235	1950		32~35	75~80	75~80	AC015	M36	18*)	standard
<b>BLTB-245-5-W</b>	10598	4525	90~130	450~550	350	300~330	70~100	245	2050		32~35	75~80	75~80	AC015	M36	18*)	standard
<b>BLTB-260-5-W</b>	11566	4659	90~160	490~590	350	300~330	80~110	260	2200	1 1/2	32~35	75~80	80~85	AC015	M36	18*)	standard
<b>BLTB-280-5-W</b>	14039	4980	120~200	550~650	350	300~330	70~100	280	2300	1 1/2	35~38	75~80	80~85	AC015	M36	18*)	standard

1\*) WORKING WEIGHT may vary depending on the version / ARBEITSGEWICHT kann je nach Ausführung abweichen | 2\*) TOTAL LENGTH / GESAMTLÄNGE | 3\*) APPLICABLE EXCAVATOR / GEEIGNETER BAGGER | 4\*) WORKING OIL FLOW / ÖLFLUSS | 5\*) SET PRESSURE / EINSTELLDRUCK | 6\*) OPERATING PRESSURE / BETRIEBSDRUCK | 7\*) IMPACT RATE / SCHLAGFREQUENZ | 8\*) CHISEL DIAMETER / MEIBELDURCHMESSER | 9\*) CHISEL LENGTH / MEIBELLÄNGE | 10\*) HOSE DIAMETER / SCHLAUCHDURCHMESSER | 11+) N2 PRESSURE (BACK HEAD) / KOLBENSPEICHERDRUCK | 12\*) N2 PRESSURE (ACCUMULATOR) / STICKSTOFFDRUCK (AKKUMULATOR) | 13\*) NOISE 85DB(A)-DISTANCE / GERÄUSCHPEGEL 85 DB(A)-ENTFERNUNG | 14\*) HOLE PATTERN / LOCHMUSTER | 15\*) BOLT SIZE / SCHRAUBENGROSSE | 16\*) MINI B@LUBE AUTOMATIC GREASING SYSTEM optional / MINI B@LUBE SCHMIERSYSTEM optional | 17\*) B@LUBE AUTOMATIC GREASING SYSTEM standard / B@LUBE SCHMIERSYSTEM standard | 18\*) BI- B@LUBE AUTOMATIC GREASING SYSTEM standard / BI-B@LUBE SCHMIERSYSTEM standard | 20\*) B@TRACK&CHECK wireless data trackers | B@TRACK&CHECK kabelloser Daten-Tracker



Member of



# 2025 KPL-SERIE

## Kopfplatten für mechanische Schnellwechsler

## Brackets for mechanical Quick Coupler



**CW00-CW70**

System Verachttert

AC02-AC14



**MS01-MS21-25**

System Lehnhoff

AC02-AC08



**S30-S70**

System Engcon, Steelwrist, OQ

AC02-AC14



**SW33-SW44**

System Liebherr

AC02-AC10



**KPL SERIE**  
**Kopfplatten**  
 für mechanische Schnellwechler  
 - System Verachtart  
 - System Lehnhoff  
 - System Liebherr  
 - System Engcon, Steelwrist, OQ

**KPL SERIES**  
**BRACKETS**  
 for mechanical Quick Couple  
 - System Verachtart  
 - System Lehnhoff  
 - System Liebherr  
 - System Engcon, Steelwrist, OQ

B-KPL-1-2025

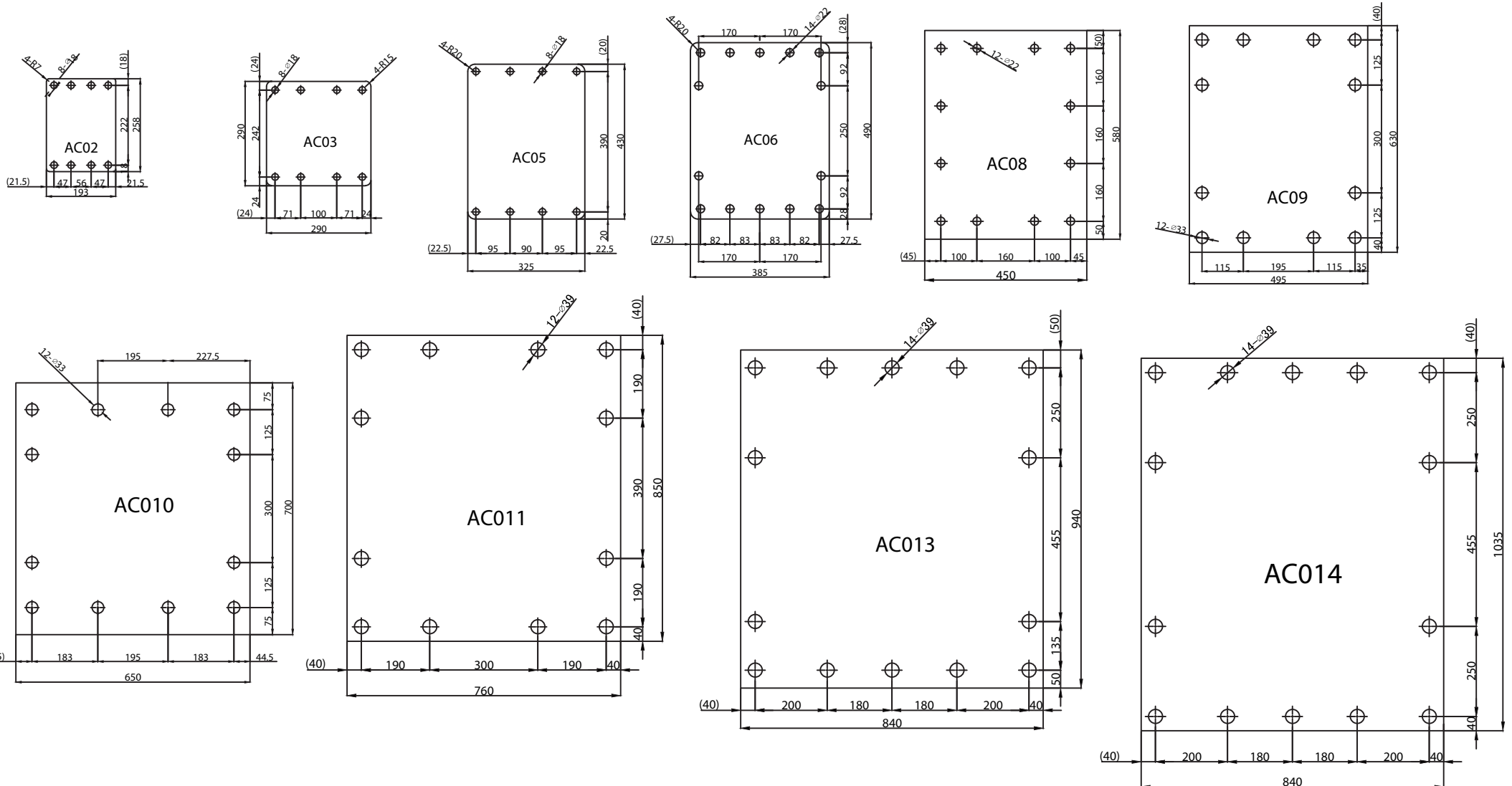



**KPL SERIE**  
**Kopfplatten**  
 für mechanische Schnellwechsler  
 - System Verachtart  
 - System Lehnhoff  
 - System Liebherr  
 - System Engcon, Steelwrist, OQ

**KPL SERIES**  
**BRACKETS**  
 for mechanical Quick Couple  
 - System Verachtart  
 - System Lehnhoff  
 - System Liebherr  
 - System Engcon, Steelwrist, OQ



	AC01	AC02	AC03	AC05	AC06	AC08	AC09	AC10	AC11	AC13	AC14	AC15
ACDE®Europe KPL Serie Kopfplatten / Brackets		KPL-CW00	KPL-CW05	KPL-CW10	KPL-CW10	KPL-CW10	KPL-CW40-AC08+AC09		KPL-CW10	KPL-CW10	KPL-CW10	
		KPL-CW05	KPL-MS03	KLP-MS03		KPL-MS08	KPL-S60-270	KPL-S70-270				
		KPL-MS01	KPL-S40-200	KPL-MS08-AC05+AC06								
		KPL-MS03		KPL-S40-200								
		KPL-S30-150		KPL-S40-240-AC05+AC06								
		KPL-S30-180			KPL-S45-290							
					KPL-S50-270							
Beilite®Europe BLTB SERIES Hammers / Breakers		BLTB-40	BLTB-53	BLTB-60	BLTB-75	BLTB-85	BLTB-100A	BLTB-150	BLTB-165	BLTB-190	BLTB-210	B LTB-255
		BLTB-45		BLTB-70			BLTB-125A	BLTB-155	BLTB-175	BLTB-195		
							BLTB-135A			BLTB-200		
							BLTB-140A					
ACDE®Europe ASG Series / (ASG-ND Series) / Greifer / Grapples		ASG/(ND)/-80	ASG/(ND)/160	ASG/(ND)/400		ASG/(ND)/600	ASG/(ND)/800	ASG/(ND)/2300				
		ASG/(ND)/105	ASG/(ND)/280	ASG/(ND)/500		ASG/(ND)/700	ASG/(ND)/1000	ASG/(ND)/2300				
							ASG/(ND)/1090	ASG/(ND)/2900				
							ASG/(ND)/1100					
							ASG/(ND)/1200					
							ASG/(ND)/1500					
							ASG/(ND)/1800					
						ASG/(ND)/2100						
ACDE®Europe AMG Series / (AMG-ND Series) / Multigreifer / Multi Grapples			AMG/(ND)/-160-370	AMG/(ND)/-460-500		AMG/(ND)/-700-800	AMG/(ND)/-1000-600	AMG/(ND)/-2100-1200				
			AMG/(ND)/-280-400	AMG/(ND)/-500-600		AMG/(ND)/-800-600	AMG/(ND)/-1000-700					
			AMG/(ND)/-280-500	AMG/(ND)/-600-500		AMG/(ND)/-800-700	AMG/(ND)/-1500-800					
				AMG/(ND)/-600-600			AMG/(ND)/-1500-900					
				AMG/(ND)/-600-700								
ACDE®Europe ACC Series Betonzange / Concrete Crusher							ACC-20					
							ACC-25					
ACDE®Europe ASS Series Schrottscheren / Scrap Shears							ASS-12	ASS-30				
							ASS-20					
ACDE®Europe ASC Series Starre Pulverisierer / Fixed Pulverizers				ASC-360			ASC-1350-2	ASC-2750-2				
				ASC-306-R			ASC-1750-2					



# Datenblätter - für jedes Model verfügbar

## Specificationsheet - available for all models



+41 62 5880164  
info@acde-europe.com  
www.acde-europe.com

ADVANCED CONSTRUCTION & DEMOLITION EQUIPMENT

🇳🇱 Sloop- en sorteergriper  
🇩🇪 Demolition and sorting grab  
🇪🇸 Abbruch- und sortiergreifer  
🇫🇷 Grappin de demolition et de triage

### ASG-500

AC05 hole pattern

zijkant/side view/  
Sellenansicht/vue de côté

vooraansicht/front view/  
Vorderansicht/vue de face

Gatenpatroon/hole pattern/  
Bohrbild/motif de trous

Technical specifications						
Nederlands	English	Deutsch	Français	ASG-500		
Klasse graafmachine	Class excavator	Machine klasse	Classe de excavatrice	ton 5-5		
Gewicht	Weight	Gewicht	Poids	kg 440		
Werkdruk max.	Op. pressure max	Druck max	Pression maximale	bar 300		
Werkdruk rotatie max.	Op. pressure rotation max	Druck rotatie max	Pression rotation max	bar 210		
Werkdruk rotatie min.	Op. pressure rotation min	Druck rotatie min	Pression rotation min	bar 190		
Olieflow max.	Oil flow max	Ölfluss max	Débit d'huile max	l/min 30		
Olieflow rotatie max.	Oil flow rotation max	Ölfluss rotatie max	Débit d'huile rotation max	l/min 12		
Inhoud	Content	Inhalt	Contenance	l 200		
Sluitkracht	Closing force	Schließkraft	Force de fermeture	kn 24		
Bergingsfunctie trijfnutcrans	How connect open/close	Schlauchanschluss knallen	Raccord de tuyau fermetur	BSP 12		
Bergingsfunctie draaifunctie	How connect turn function	Schlauchanschluss drehen	Raccord de tuyau rotation	BSP 12		

+41 62 5880164  
info@acde-europe.com  
www.acde-europe.com

ADVANCED CONSTRUCTION & DEMOLITION EQUIPMENT

🇳🇱 Sloop- en sorteergriper  
🇩🇪 Demolition and sorting grab  
🇪🇸 Abbruch- und sortiergreifer  
🇫🇷 Grappin de demolition et de triage

### ASG-1000

AC09 hole pattern

zijkant/side view/  
Sellenansicht/vue de côté

vooraansicht/front view/  
Vorderansicht/vue de face

Gatenpatroon/hole pattern/  
Bohrbild/motif de trous

Technical specifications						
Nederlands	English	Deutsch	Français	ASG-1000		
Klasse graafmachine	Class excavator	Machine klasse	Classe de excavatrice	ton 2-30		
Gewicht	Weight	Gewicht	Poids	kg 300		
Werkdruk max.	Op. pressure max	Druck max	Pression maximale	bar 300		
Werkdruk rotatie max.	Op. pressure rotation max	Druck rotatie max	Pression rotation max	bar 210		
Werkdruk rotatie min.	Op. pressure rotation min	Druck rotatie min	Pression rotation min	bar 190		
Olieflow max.	Oil flow max	Ölfluss max	Débit d'huile max	l/min 120		
Olieflow rotatie max.	Oil flow rotation max	Ölfluss rotatie max	Débit d'huile rotation max	l/min 21		
Inhoud	Content	Inhalt	Contenance	l 200		
Sluitkracht	Closing force	Schließkraft	Force de fermeture	kn 42		
Bergingsfunctie trijfnutcrans	How connect open/close	Schlauchanschluss knallen	Raccord de tuyau fermetur	BSP 14		
Bergingsfunctie draaifunctie	How connect turn function	Schlauchanschluss drehen	Raccord de tuyau rotation	BSP 12		

+41 62 5880164  
info@acde-europe.com  
www.acde-europe.com

ADVANCED CONSTRUCTION & DEMOLITION EQUIPMENT

🇳🇱 Sloop- en sorteergriper  
🇩🇪 Demolition and sorting grab  
🇪🇸 Abbruch- und sortiergreifer  
🇫🇷 Grappin de demolition et de triage

### ASG-1500

AC09 hole pattern

zijkant/side view/  
Sellenansicht/vue de côté

vooraansicht/front view/  
Vorderansicht/vue de face

Gatenpatroon/hole pattern/  
Bohrbild/motif de trous

Technical specifications						
Nederlands	English	Deutsch	Français	ASG-1500		
Klasse graafmachine	Class excavator	Machine klasse	Classe de excavatrice	ton 17-28		
Gewicht	Weight	Gewicht	Poids	kg 300		
Werkdruk max.	Op. pressure max	Druck max	Pression maximale	bar 300		
Werkdruk rotatie max.	Op. pressure rotation max	Druck rotatie max	Pression rotation max	bar 210		
Werkdruk rotatie min.	Op. pressure rotation min	Druck rotatie min	Pression rotation min	bar 190		
Olieflow max.	Oil flow max	Ölfluss max	Débit d'huile max	l/min 120		
Olieflow rotatie max.	Oil flow rotation max	Ölfluss rotatie max	Débit d'huile rotation max	l/min 21		
Inhoud	Content	Inhalt	Contenance	l 200		
Sluitkracht	Closing force	Schließkraft	Force de fermeture	kn 42		
Bergingsfunctie trijfnutcrans	How connect open/close	Schlauchanschluss knallen	Raccord de tuyau fermetur	BSP 14		
Bergingsfunctie draaifunctie	How connect turn function	Schlauchanschluss drehen	Raccord de tuyau rotation	BSP 12		

+41 62 5880164  
info@acde-europe.com  
www.acde-europe.com

ADVANCED CONSTRUCTION & DEMOLITION EQUIPMENT

🇳🇱 Sloop- en sorteergriper  
🇩🇪 Demolition and sorting grab  
🇪🇸 Abbruch- und sortiergreifer  
🇫🇷 Grappin de demolition et de triage

### ASG-2900

AC10 hole pattern

zijkant/side view/  
Sellenansicht/vue de côté

vooraansicht/front view/  
Vorderansicht/vue de face

Gatenpatroon/hole pattern/  
Bohrbild/motif de trous

Technical specifications						
Nederlands	English	Deutsch	Français	ASG-2900		
Klasse graafmachine	Class excavator	Machine klasse	Classe de excavatrice	ton 30-50		
Gewicht	Weight	Gewicht	Poids	kg 2000		
Werkdruk max.	Op. pressure max	Druck max	Pression maximale	bar 300		
Werkdruk rotatie max.	Op. pressure rotation max	Druck rotatie max	Pression rotation max	bar 210		
Werkdruk rotatie min.	Op. pressure rotation min	Druck rotatie min	Pression rotation min	bar 190		
Olieflow max.	Oil flow max	Ölfluss max	Débit d'huile max	l/min 200		
Olieflow rotatie max.	Oil flow rotation max	Ölfluss rotatie max	Débit d'huile rotation max	l/min 35		
Inhoud	Content	Inhalt	Contenance	l 1100		
Sluitkracht	Closing force	Schließkraft	Force de fermeture	kn 90		
Bergingsfunctie trijfnutcrans	How connect open/close	Schlauchanschluss knallen	Raccord de tuyau fermetur	BSP G1		
Bergingsfunctie draaifunctie	How connect turn function	Schlauchanschluss drehen	Raccord de tuyau rotation	BSP G1/2		

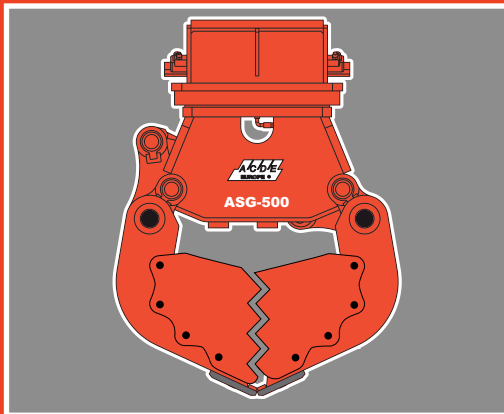

**Anschaub Schilder 100% Brechzahn**

**Side bords - tooth 100%**

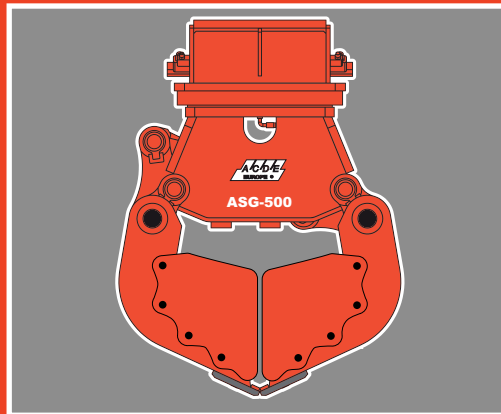

**Anschaub Schilder 100% Glatt**

**Side bords - straight 100%**

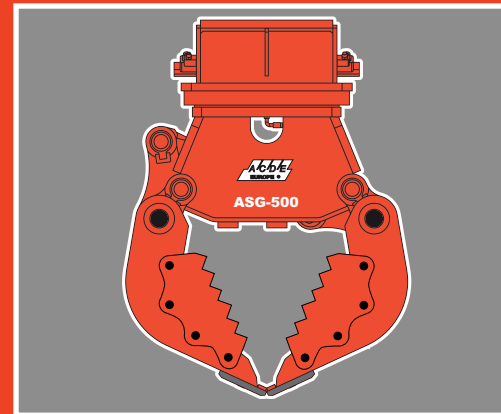

**Anschaub Schilder 30% Brechzahn**

**Side bords - tooth 30%**

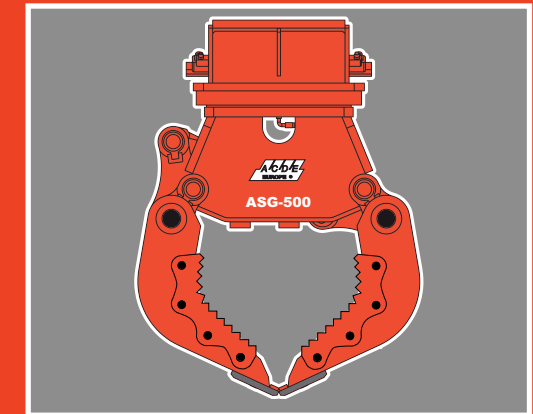

**Anschaub Schilder Zahnreihe**

**Side bords - tooth**