

ACDE





EUROPE[®]

+41 62 5880164

info@acde-europe.com

www.acde-europe.com

ADVANCED CONSTRUCTION & DEMOLITION EQUIPMENT

-  Sloop- en sorteergrijper
-  Demolition and sorting grab
-  Abbruch- und sortiergreifer
-  Grappin de demolition et de triage

ASG-1800-2M

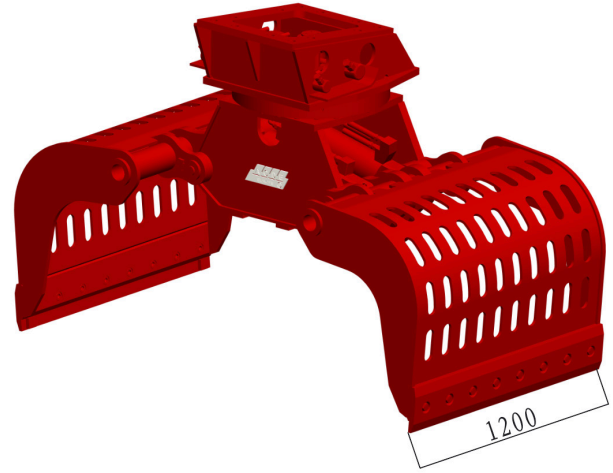

zijkant/side view /
Seitenansicht/vue de côté

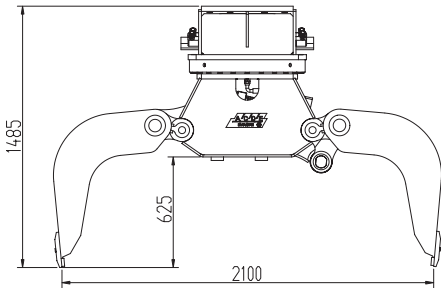



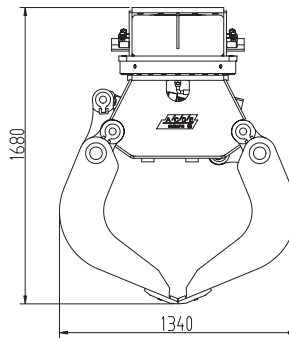

vooraanzicht/front view/
Vorderansicht/vue de face

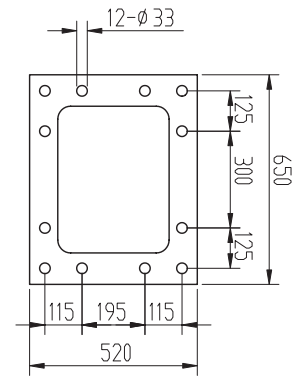

Gatenpatroon/hole pattern/
Bohrbild/motif de trous



Technical specifications

Nederlands 	English 	Deutsch 	Français 		ASG-1800
Klasse graafmachine	Class excavator	Machine klasse	Classe de excavatrice	ton	20-28
Gewicht	Weight	Gewicht	Poids	Kg	1540
Werkdruk max.	Op. pressure max	Betät. druck max	Pression maximale	bar	350
Werkdruk rotatie max	Op. pressure rotation max	Betät. druck rotation max	Pression rotation max	bar	210
Werkdruk rotatie min	Op. pressure rotation min	Betät. druck rotation min	Pression rotation min	bar	190
Olieflow max	Oil flow max	Ölfluss max	Débit d'huile max	l/min	120
Olieflow rotatie max	Oil flow rotation max	Ölfluss rotation max	Débit d'huile rotation max	l/min	25
Inhoud	Content	Inhalt	Contenance	ltr	850
Sluitkracht	Closing force	Schliesskraft	Force de fermeture	kN	68
Slangaansluiting knijpfunctie	Hose connect open/close	Schlauchanschluss kneifen	Raccord de tuyau fermeture	-	BSP 3/4
Slangaansluiting draaifunctie	Hose connect turn function	Schlauchanschluss drehen	Raccord de tuyau rotation	-	BSP 1/2