

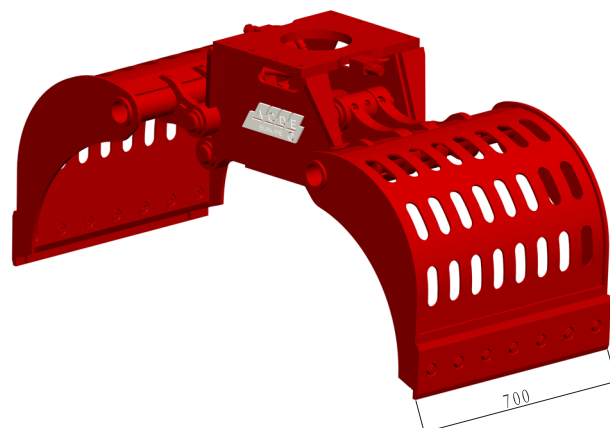

ADVANCED CONSTRUCTION & DEMOLITION EQUIPMENT

- Sloop- en sorteergrijper
- Demolition and sorting grab
- Abbruch- und sortiergreifer
- Grappin de demolition et de triage

ASG-500-ND AC05 hole pattern



**zijkant/side view/
Seitenansicht/vue de côté**

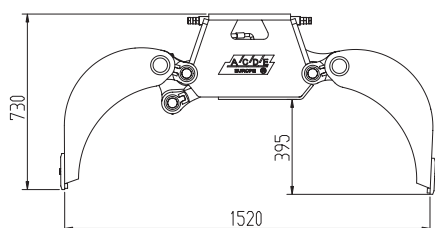

**vooraanzicht/front view/
Vorderansicht/vue de face**

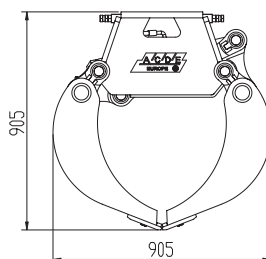

**Gatenpatroon/hole pattern/
Bohrbild/motif de trous**

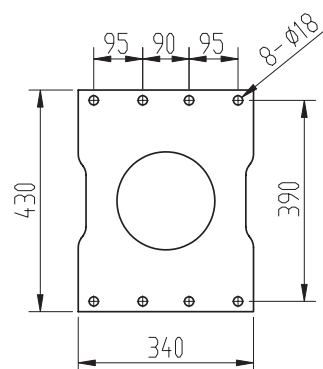

Technical specifications

Nederlands	English	Deutsch	Français		ASG-500-ND
Klasse graafmachine	Class excavator	Machine klasse	Classe de excavatrice	ton	5-8
Gewicht	Weight	Gewicht	Poids	Kg	60
Werkdruk max.	Op. pressure max	Betät. druck max	Pression maximale	bar	300
Werkdruk rotatie max	Op. pressure rotation max	Betät. druck rotation max	Pression rotation max	bar	/
Werkdruk rotatie min	Op. pressure rotation min	Betät. druck rotation min	Pression rotation min	bar	/
Olieflow max	Oil flow max	Ölfluss max	Débit d'huile max	l/min	50
Olieflow rotatie max	Oil flow rotation max	Ölfluss rotation max	Débit d'huile rotation max	l/min	/
Inhoud	Content	Inhalt	Contenance	ltr	200
Sluitkracht	Closing force	Schliesskraft	Force de fermeture	kN	24
Slangaansluiting knijpfunctie	Hose connect open/close	Schlauchanschluss kneifen	Raccord de tuyau fermeture	-	BSP 1/2
Slangaansluiting draaifunctie	Hose connect turn function	Schlauchanschluss drehen	Raccord de tuyau rotation	-	