

Seriennummer: _____ bis _____

Serial number: _____ up to _____



ORIGINAL ACDE EUROPE ERSATZTEILLE

Echte ACDE Europe-Ersatzteile werden nach dem neuesten technologischen Erkenntnisstand und mit modernsten ingenieurtechnischen Mitteln konzipiert und gefertigt. ACDE Europe-Ersatzteile werden aus den besten auf dem Markterhältlichen Materialien und mit Hilfe modernster Fertigungsmethoden hergestellt.

Es ist von größter Wichtigkeit, dass Sie nur echte Acde Europe-Ersatzteile verwenden, um auf diese Weise einen problemlosen Betrieb sowie eine leichte Wartung und Reparatur des Pulverisierer sicherzustellen. Bitte beachten Sie, dass eventuelle Garantieansprüche nur dann bearbeitet werden können. Wenn Sie echte Acde Europe-Ersatzteile für Ihren Pulverisierer verwendet haben.

VERMERK DER SERIENNUMMER

Es ist wichtig, dass Sie bei der Bestellung von Ersatzteilen die korrekte Seriennummer des Pulverisierer angeben können. Die Seriennummer bietet die einzige Möglichkeit, die zu einem bestimmten Pulverisierer gehörigen Teile zu identifizieren. Die Seriennummer ist auf dem CE-Schild am Pulverisierer geäuse vermerkt.

ERSATZTEILBESTELLUNG

Präzise Bestellungen bilden die Grundlage für schnelle Ersatzteillieferungen.

ERFORDERLICHE ANGABEN:

- Name des Kunden und der Kontaktperson
- Bestellnummer (falls vorhanden)
- Lieferanschrift
- Lieferart (Luftpost, ect.)
- Gewünschter Liefertermin
- Rechnungsanschrift
- Modell und Seriennummer des Hammers
- Bezeichnung, Nummer und erforderliche Anzahl der Ersatzteile

GENUINE ACDE EUROPE SPARE PARTS

ACDE EUROPE genuine spare parts are designed and manufactured by using the latest technological knowledge and engineering skills. ACDE EUROPE spare parts are made of the best available materials with the most advanced manufacturing techniques.

It is important that you use only genuine ACDE EUROPE spare parts, to ensure easy operation, maintenance and repair of the product. Please note that eventual warranty claims will be handled only if you have used genuine ACDE EUROPE parts in your ACDE EUROPE.

LOCATION OF THE SERIAL NUMBER

It's important to make correct reference to the serial number of the product when ordering spare parts. Identification of serial number is the only proper means of maintaining and identifying parts for a specific product. The location of equipment serial number is pointed in "Operation and maintenance" manual.

SPARE PARTS ORDERS

Quick spare parts deliveries are secured by exact orders.

REQUIERD INFORMATION:

- Name of customer and contact person
- Order number (when available)
- Delivery address
- Mode of delivery (air mail ect.)
- Required delivery date
- Invoicing address
- Model and serial number of the product
- Name, number and required amount of spare parts

INHALTS VERZEICHNIS

- Zeichnung ASG-2300-2–Gesamt	4
- Stuckliste ASG-2300-2–Gesamt	5
- Zeichnung Zylinder ASG-2300-2 Links.....	7
- Stuckliste Zylinder ASG-2300-2 Links.....	7
- Zeichnung Zylinder ASG-2300-2 Rechts.....	8
- Stuckliste Zylinder ASG-2300-2 Rechts.....	8
- Zeichnung C.O.D ASG-2300-2	9
- Stuckliste C.O.D ASG-2300-2.....	9
- Dichtsatz ASG-2300-2 Zylinder	10
- Dichtsatz ASG-2300-2 C.O.D	11

CONTENTS

- Exploded View Of ASG-2300-2 Total	4
- Parts List Of ASG-2300-2 Total	5
- Exploded View Of ASG-2300-2 Cylinder Left.....	7
- Parts List Of ASG-2300-2 Cylinder Left.....	7
- Exploded View Of ASG-2300-2 Cylinder Right.....	8
- Parts List Of ASG-2300-2 Cylinder Right.....	8
- Exploded View Of ASG-2300-2 C.O.D	9
- Parts List Of ASG-2300-2 C.O.D.....	9
- Seal Kits Of ASG-2300-2 Cylinder	10
- Seal Kits Of ASG-2300-2 C.O.D	11

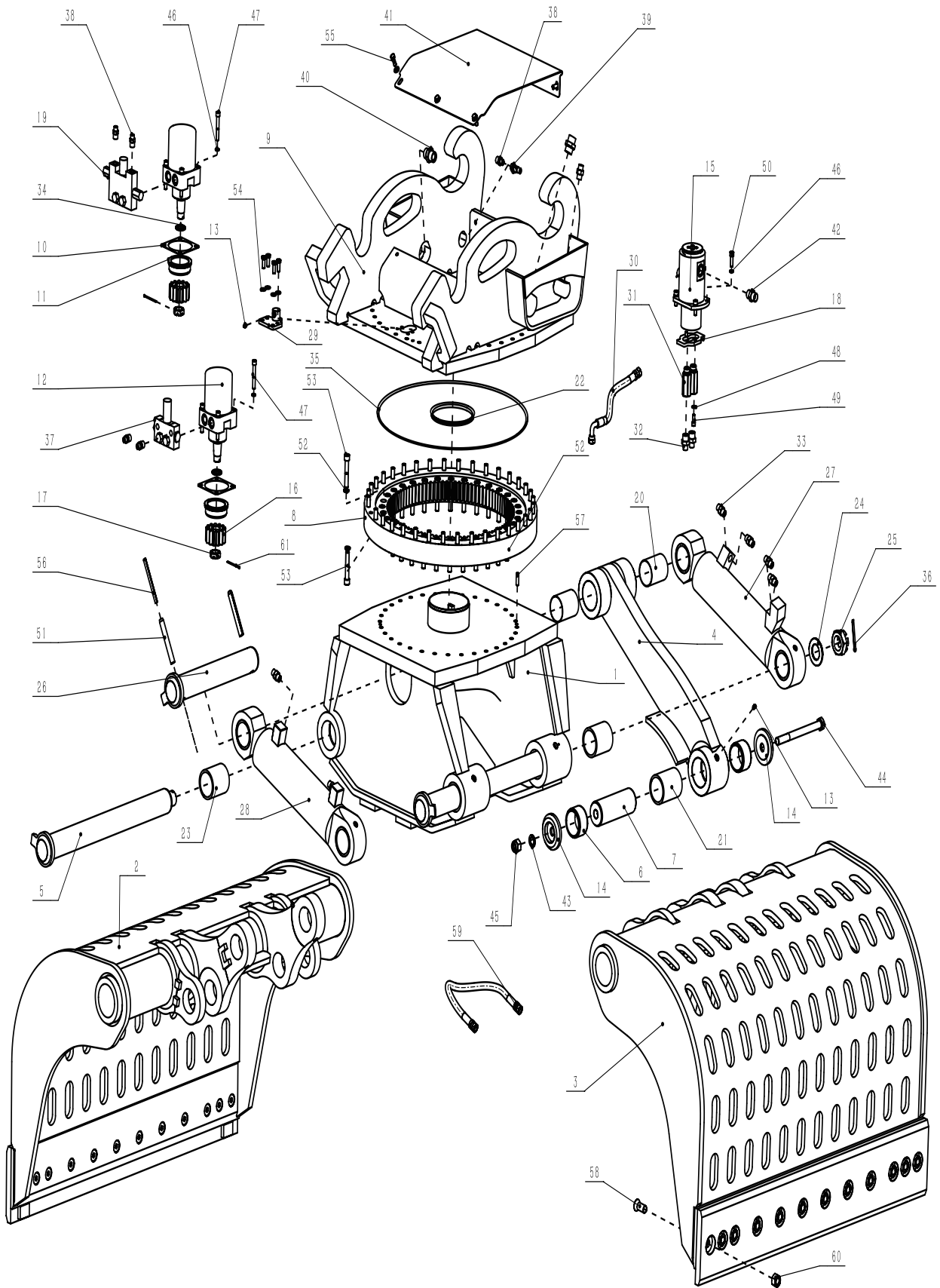

NO.	PART NO/ART.-NR.	QTY	DESCRIPTION - GB	BESCHREIBUNG-DE
1	ASG-2-2300-001	1 PCS	WELDED MAIN FRAME	GESCHWEISSTE HAUPTTRAHMENKONSTRUKTION
2	ASG-2-2300-003	1 PCS	SHELL LEFT (SHORT LEVER)	LÖFFEL LINKS KURZER HENKEL
3	ASG-2-2300-004	1 PCS	SHELL RIGHT (LONG LEVER)	LÖFFEL RECHTS LANGER HENKEL
4	ASG-2-2100*2300-005	1 PCS	WELDED LINKAGE CONSTRUCTION	ZUGSTANGE
5	ASG-2-P-2100*2300-013	2 PCS	MAIN HINGE PIN	HAUPTGELENKBOLZEN
6	ASG-2-WB-2100*2300-050	2 PCS	BUSHING	GLEITLAGER
7	ASG-2-P-2100*2300-014	1 PCS	LINKAGE AXIS(UNDER / SHORT)	ZUGSTANGE ACHSE (UNTEN/KURZ)
8	ASG-SLR-005-2100*2300	1 PCS	SLEWING RING	DREHKRANZLAGER
9	ASG-2100-002-CW40	1 PCS	WELDED ROTATOR FRAME CONSTRUCTION	GESCHWEISSTE BACKENKONSTRUKTION
10	ASG-2300-007	1 PCS	GASKET	FLACHDICHTUNG
11	ASG-2300-029	2 PCS	BUSHING	GLEITLAGER
12	ASG-MOT-002-450*2900	2 PCS	HYDRAULIC MOTOR	HYDRO-MOTOR
13	ASG-2300-043	1 SET	GREASE NIPPLE(13 PCS)	SCHMIERNIPPEL(13 STÜCK)
14	ASG-2300-017	2 PCS	END CAP	ENDDECKEL
15	ASG-COD-003-800*2900	1 PCS	C.O.D. COMPLETE	ZENTRALDREHDURCHFÜHRUNG
16	ASG-GEA-003-1800*2900	2 PCS	GEAR	ZAHNRAD
17	ASG-2300-011	2 PCS	NUT	SICHERUNGSMUTTER
18	ASG-2300-012	1 PCS	PLATE	PLATTE
19	ASG-RVA-002	1 SET	RELIEF VALVE ASS'Y	ENTLASTUNGSVENTIL
20	ASG-2-WB-2100*2300-047	2 PCS	BUSHING	GLEITLAGER
21	ASG-2-WB-2100*2300-049	1 PCS	BUSHING	GLEITLAGER
22	ASG-SLR-005-SEAL-2100*2300	1 PCS	SEAL	DICHTUNG
23	ASG-2-WB-2100*2300-022	4 PCS	BUSHING	GLEITLAGER
24	ASG-2300-016	2 PCS	DISK SPRING	FEDERSCHEIBE
25	ASG-2300-019	2 PCS	HEXAGON SLOTTED NUT	NUTMUTTER
26	ASG-2-P-2100*2300-015	1 PCS	LINKAGE AXIS(TOP / LONG)	ZUGSTANGE ACHSE (OBEN/LANG)
27	ASG-CYL-2100*2300-010	1 PCS	HYDRAULIC CYLINDER(4 PORTS)	HYDRAULISCHER ZYLINDER(RECHTS)
28	ASG-CYL-2100*2300-009	1 PCS	HYDRAULIC CYLINDER(2 PORTS)	HYDRAULISCHER ZYLINDER(LINKS)
29	ASG-2300-021	1 PCS	GREASE FITTING	FETT
30	ASG-2300-030	1 SET	HOSE KITS/SET	SLAUCH/SET
31	ASG-2300-006	2 PCS	CONNECTOR	ROHRVERBINDER
32	ASG-2300-023	2 PCS	CONNECTOR	ROHRVERBINDER
33	ASG-2300-025	8 PCS	CONNECTOR	ROHRVERBINDER
34	ASG-MOT-002-450*2900-SKX	2 SET	SEAL KITS (MOTOR)	DICHTUNGS-KITS (MOTOR)
35	ASG-2300-024	1 PCS	SEAL RING	DICHTUNG
36	ASG-2300-018	2 PCS	SPLIT PIN	SPANNSTIFT
37	ASG-RVA-001	2 SET	RELIEF VALVE ASS'Y	ENTLASTUNGSVENTIL
38	ASG-2300-027	6 PCS	CONNECTOR	ROHRVERBINDER
39	ASG-2300-028	2 PCS	T-CONNECTOR	T-VERBINDUNGSSTÜCK
40	ASG-2300-026	2 PCS	CONNECTOR	ROHRVERBINDER
41	ASG-2300-031	1 PCS	COVER PLATE	SCHUTZPLATTE
42	ASG-2300-035	2 PCS	CONNECTOR	ROHRVERBINDER

NO.	PART NO/ART.-NR.	QTY	DESCRIPTION - GB	BESCHREIBUNG-DE
43	ASG-2300-038	1 PCS	NORD LOCK	ANTI-LOSE-DICHTUNG
44	ASG-2300-039	1 PCS	HEX BOLT	SECHSKANTSCHRAUBE
45	ASG-2300-040	1 PCS	SELF-LOCKING NUT	SICHERUNGSMUTTER
46	ASG-2300-033	1 SET	NORD LOCK(12XD12)	ANTI-LOSE-DICHTUNG(12XD12)
47	ASG-2300-032	1 SET	HEX SOCKET CSK SCREWS(8XM12X60)	INNEN-SECHSKANTBOLZEN
48	ASG-2300-037	1 SET	DISK SPRING(2XD10)	FEDERSCHEIBE
49	ASG-2300-036	1 SET	HEX SOCKET CSK SCREWS(2XM10X25)	INNEN-SECHSKANTBOLZEN
50	ASG-2300-034	1 SET	HEX SOCKET CSK SCREWS(4XM12X35)	INNEN-SECHSKANTBOLZEN
51	ASG-2300-041	1 SET	SPRING PIN(2XD20X150)	SPANNSTIFT
52	ASG-2300-042	1 SET	NORD LOCK (68XD16)	ANTI-LOSE-DICHTUNG
53	ASG-2300-043	1 SET	HEX SOCKET CSK SCREWS(68XM16X90)	INNEN-SECHSKANTBOLZEN
54	ASG-2300-044	1 SET	DISK SPRING(11XD12)	FEDERSCHEIBE
55	ASG-2300-045	1 SET	HEX BOLT(10XM12X30)	SECHSKANTSCHRAUBE
56	ASG-2300-046	1 SET	SPRING PIN(2XD12X150)	SPANNSTIFT
57	ASG-2300-047	1 SET	DOWEL PIN(2XD12X40)	POSITIONIERSTIFT
58	ASG-2-BM-1800*2100*2300	1 SET	HEX SOCKET CSK SCREWS(22XM24)	INNEN-SECHSKANTBOLZEN
60		1 SET	NUT	MUTTER
59	ASG-CB-2-1800*2100*2300-020	2 PCS	EXCHANGEABLE WEAR BLADES	WECHSELMESSER
61	ASG-2300-061	2 PCS	SPLIT PIN	SPANNSTIFT

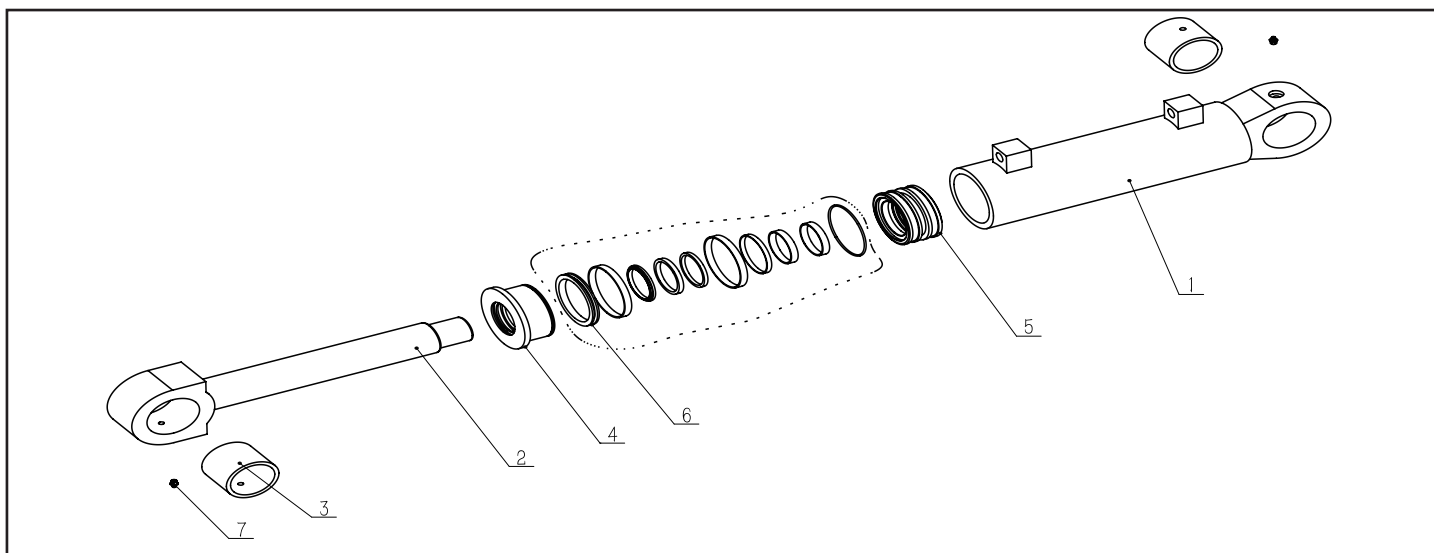

NO.	PART NO/ART.-NR.	QTY	DESCRIPTION - GB	BESCHREIBUNG-DE
	ASG-CYL-2100*2300-009	1 PCS	HYDRAULIC CYLINDER(2 PORTS)	HYDRAULISCHER ZYLINDER(LINKS)
1	ASG-CYL-2100*2300-201	1 PCS	CYLINDER HOUSING	ZYLINDER ROHR
2	ASG-CYL-2100*2300-202	1 PCS	PISTON ROD	ZYLINDER STANGE
3	ASG-WB-CYL-2100*2300-206	2 PCS	BUSHING	GLEITLAGER RORHR
4	ASG-CYL-2100*2300-204	1 PCS	ROD GUIDE	FÜHRUNGSBUCHSE
5	ASG-CYL-2100*2300-205	2 PCS	PISTON	ZYLINDER KOLBEN
6	ASG-CYL-2100*2300-SKX	1 SET	SEAL KIT(CYLINDER)	DICHTUNGS-KIT (ZYLINDER)
7	ASG-CYL-2100*2300-207	1 SET	GREASE NIPPLE(2 PCS)	FETTNIPEL(2 STUCK)

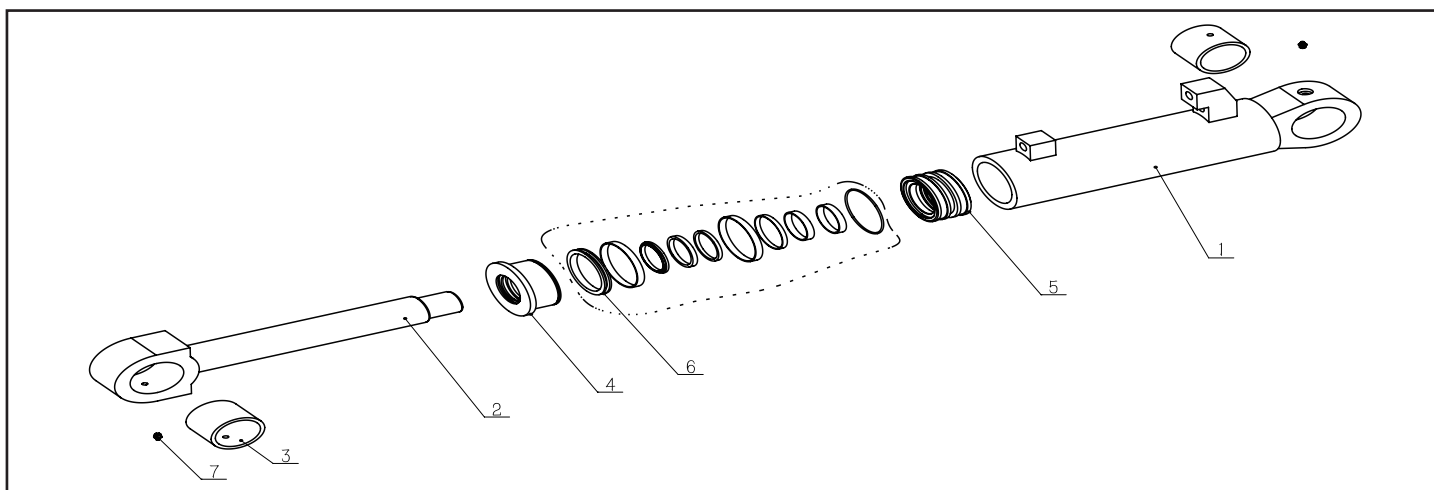

NO.	PART NO/ART.-NR.	QTY	DESCRIPTION - GB	BESCHREIBUNG-DE
	ASG-CYL-2100*2300-010	1 PCS	HYDRAULIC CYLINDER(4 PORTS)	HYDRAULISCHER ZYLINDER(RECHTS)
1	ASG-CYL-2100*2300-201	1 PCS	CYLINDER HOUSING	ZYLINDER ROHR
2	ASG-CYL-2100*2300-202	1 PCS	PISTON ROD	ZYLINDER STANGE
3	ASG-WB-CYL-2100*2300-206	2 PCS	BUSHING	GLEITLAGER RORHR
4	ASG-CYL-2100*2300-204	1 PCS	ROD GUIDE	FÜHRUNGSBUCHSE
5	ASG-CYL-2100*2300-205	2 PCS	PISTON	ZYLINDER KOLBEN
6	ASG-CYL-2100*2300-SKX	1 SET	SEAL KIT(CYLINDER)	DICHTUNGS-KIT (ZYLINDER)
7	ASG-CYL-2100*2300-207	1 SET	GREASE NIPPLE(2 PCS)	FETTNIPEL(2 STUCK)

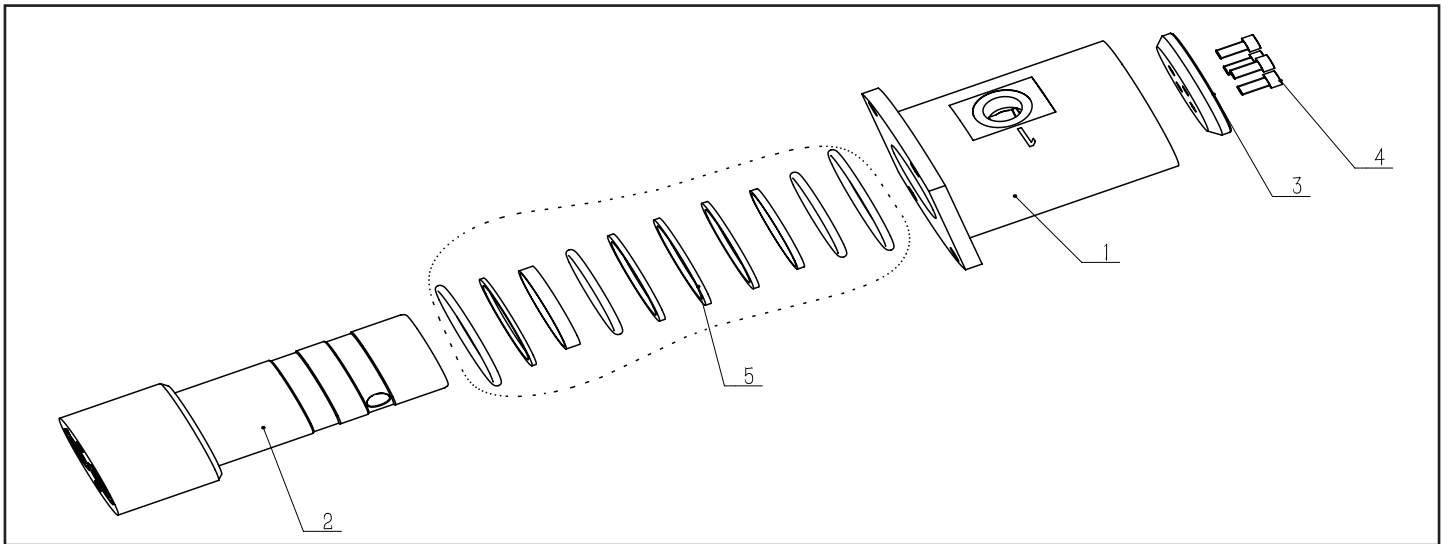

NO.	PART NO/ART.-NR.	QTY	DESCRIPTION - GB	BESCHREIBUNG-DE
	ASG-COD-003-800*2900	1 PCS	C.O.D. COMPLETE	ZENTRALDREHDURCHFÜHRUNG
1	ASG-COD-003-800*2900-001	1 PCS	C.O.D. HOUSING	C.O.D.HÜLSE
2	ASG-COD-003-800*2900-002	1 PCS	C.O.D. ROTOR	C.O.D.ASCHE
3	ASG-COD-003-800*2900-003	2 PCS	C.O.D. COVER	C.O.D.DECKEL
4	ASG-COD-003-800*2900-004	1 PCS	C.O.D. COVER	C.O.D.DECKEL
5	ASG-COD-003-800*2900-SKX	1 SET	SEAL KITS (C.O.D. COMPLETE)	DICHTUNGS-KITS (C.O.D. KOMPLETT)

NO.	COMPONENT NO.	PART NO/ART.-NR.	QTY	DESCRIPTION - GB	BESCHREIBUNG-DE
-1	ASG-CYL-2100*2300-SKX		1 SET	SEAL KIT(CYLINDER)	DICHTUNGS-KIT (ZYLINDER)
-2	ASG-COD-003-800*2900-SKX		1 Set	SEAL KITS (C.O.D. COMPLETE)	DICHTUNGS-KITS (C.O.D. KOMPLETT)
-3	ASG-2-WB-2100*2300-ASS		1 SET	BUSHING SET	GLEITLAGER-SET
		ASG-2-WB-2100*2300-050	2 PCS	BUSHING	GLEITLAGER
		ASG-2-WB-2100*2300-047	2 PCS	BUSHING	GLEITLAGER
		ASG-2-WB-2100*2300-049	1 PCS	BUSHING	GLEITLAGER
		ASG-2-WB-2100*2300-022	4 PCS	BUSHING	GLEITLAGER
-4	ASG-P-1200*1500*1800-ASS		1 SET	PIN KITS	BOLZEN-KIT
1		ASG-2-P-2100*2300*013	2 PCS	MAIN HINGE PIN	HAUPTGELENKBOLZEN
2		ASG-2-P-2100*2300*014	1 PCS	LINKAGE AXIS(UNDER / SHORT)	ZUGSTANGE ACHSE (UNTEN/KURZ)
3		ASG-2-P-2100*2300*015	1 PCS	LINKAGE AXIS(TOP / LONG)	ZUGSTANGE ACHSE (OBEN/LANG)
-5	ASG-CB-2-1800*2100*2300-ASS		1 SET	BLADES KITS	MESSERSATZ
		ASG-CB-2-1800*2100*2300-020	2 PCS	EXCHANGEABLE WEAR BLADES	WECHSELMESSER
		ASG-2-BM-1800*2100*2300	1 SET	HEX SOCKET CSK SCREWS(22XM24)	INNEN-SECHSKANTBOLZEN
			1 SET	NUT	MUTTER



ADVANCED CONSTRUCTION & DEMOLITION EQUIPMENT

www.acde-europe.com

Any unauthorized use or copying of the contents or any part thereof is prohibited. This applies in particular to trademarks, model denominations, part numbers and drawings.

